



# LFM550M SERIES 550 WATT MEDICAL AC-DC POWER SUPPLY WITH PFC

## Features

- Universal Input Range 85~264Vac
- High Efficiency up to 94%
- Class I & Class II
- 25.4mm Low Profile Package
- Approval Safety IEC/EN/UL 60601-1 2 MOPP
- Approval Safety IEC/EN/UL 62368-1
- Meets IEC/EN 60335-1
- Operating Altitude 5000m
- Continuous Short Circuit Protection
- Over Voltage Protection
- Over Temperature Protection
- High Power Density 36.66W/Inches<sup>3</sup>
- Active PFC Function



MODEL NUMBER	OUTPUT VOLTAGE	OUTPUT CURRENT			RIPPLE & NOISE NOTE1	VOLTAGE ACCURACY NOTE2	VOLTAGE ADJ. RANGE	LINE REGULATION NOTE3	LOAD REGULATION NOTE4	% EFF. (Typ.) NOTE5
		With Fan NOTE6	With Conduction Cooling NOTE7							
			Baseplate	Cover						
LFM550M120	12 V	45.83 A	29.17 A	37.5 A	120 mV	±1%	11.4-12.6 V	±0.3%	±0.5%	92%
LFM550M150	15 V	36.66 A	23.33 A	30 A	150 mV	±1%	14.25-15.75 V	±0.3%	±0.5%	93%
LFM550M240	24 V	22.91 A	14.58 A	18.75 A	200 mV	±1%	22.8-25.2 V	±0.3%	±0.5%	93%
LFM550M280	28 V	19.64 A	12.5 A	16.07 A	200 mV	±1%	28-29.4 V	±0.3%	±0.5%	93%
LFM550M300	30 V	18.33 A	11.66 A	15 A	200 mV	±1%	28.5-31.5 V	±0.3%	±0.5%	93%
LFM550M360	36 V	15.27 A	9.72 A	12.5 A	200 mV	±1%	34.2-37.8 V	±0.3%	±0.5%	94%
LFM550M480	48 V	11.45 A	7.29 A	9.37 A	200 mV	±1%	45.6-50.4 V	±0.3%	±0.5%	94%
LFM550M540	54 V	10.18 A	6.48 A	8.34 A	200 mV	±1%	51.3-56.7 V	±0.3%	±0.5%	94%

Note:

1. Add a 0.1uF ceramic capacitor and a 10uF E.L. capacitor to output for ripple & noise measuring@20MHz BW.
2. Voltage accuracy is set at full load.
3. Line regulation is measured from 100Vac to 240Vac with full load.
4. Load regulation is measured from 10% to 100% full load.
5. Typical efficiency at 230 Vac and full load at 25°C.
6. Forced air convection with 21.9CFM above 110Vac.
7. With addition cooling conduction plate, 38.1 by 38.1 cm with min. 0.2 cm thick, as below.



# LFM550M Series

## PART NUMBER

Series	Number of Outputs	Nominal Output Voltage	Type	Mounting Inserts
LFM550	O	XXX	X	-YZ
LFM550	M : Medical	120 : 12V 150 : 15V 240 : 24V 280 : 28V 300 : 30V 360 : 36V 480 : 48V 540 : 54V	B : With Baseplate C : With Cover	Blank : Through Hole C0 : Threaded Hole

Part Number Example:

**LFM550M120C-C0:** With Cover 550W, Medical 12Vdc Output, Threaded Hole

**LFM550M240B:** With Baseplate 550W, Medical 24Vdc Output, Through Hole



# LFM550M Series

## TECHNICAL SPECIFICATIONS

(All specifications are typical at nominal input, full load at 25°C unless otherwise noted.)

### ABSOLUTE MAXIMUM RATINGS

PARAMETER	NOTES and CONDITIONS	Device	Min.	Typ.	Max.	Units
Input Voltage	Safety approvals only to the AC input	All	85		264	V <sub>ac</sub>
				115		370
Operating Temperature	<b>See derating curve</b>	All	-40		80	°C
Operating Case Temperature	At the center of base plate (T <sub>c</sub> = Case temperature)	All	-40		90	°C
Storage Temperature		All	-40		90	°C
Operating Altitude		All			5000	m

### INPUT CHARACTERISTICS

PARAMETER	NOTES and CONDITIONS	Device	Min.	Typ.	Max.	Units
Operating Voltage Range		All	100		240	V <sub>ac</sub>
Input Frequency Range		All	47		63	Hz
Maximum Input Current	100% Load, V <sub>in</sub> =100V <sub>ac</sub>	All			6.3	A
Leakage Current	Contact leakage current	All			100	uA
	Earth leakage current				300	
Inrush Current	V <sub>in</sub> =240V <sub>ac</sub> , Cold start @25°C	All			45	A
Power Factor	230V <sub>ac</sub> @ Full load	All	0.96	0.98		

### OUTPUT CHARACTERISTICS

PARAMETER	NOTES and CONDITIONS	Device	Min.	Typ.	Max.	Units
Output Voltage Set Point	V <sub>in</sub> =Nominal V <sub>in</sub> , I <sub>o</sub> =I <sub>o</sub> max., T <sub>c</sub> =25°C	LFM550M120	11.88	12	12.12	V <sub>dc</sub>
		LFM550M150	14.85	15	15.15	
		LFM550M240	23.76	24	24.24	
		LFM550M280	27.72	28	28.28	
		LFM550M300	29.7	30	30.3	
		LFM550M360	35.64	36	36.36	
		LFM550M480	47.52	48	48.48	
		LFM550M540	53.46	54	54.54	
Operating Output Current Range	V <sub>in</sub> =85V <sub>ac</sub> ~264V <sub>ac</sub> , <b>see derating curve</b>	LFM550M120	0		45.83	A
		LFM550M150	0		36.66	
		LFM550M240	0		22.91	
		LFM550M280	0		19.64	
		LFM550M300	0		18.33	
		LFM550M360	0		15.27	
		LFM550M480	0		11.45	
		LFM550M540	0		10.18	
Holdup Time	V <sub>in</sub> =115V <sub>ac</sub>	All	8	12		ms
Output Voltage Regulation						
Load Regulation	10% Load to full load	All			±0.5	%
Line Regulation	V <sub>in</sub> =High line to low line	All			±0.3	%
Output Voltage Adjustment	P <sub>o</sub> ≤ max. rated power, I <sub>o</sub> ≤ I <sub>o</sub> max.	LFM550M280	0		+5	%
		Others	-5		+5	



# LFM550M Series

PARAMETER	NOTES and CONDITIONS	Device	Min.	Typ.	Max.	Units
Over Voltage Protection	Latch off (AC recycle to reset)	LFM550M120			16	V <sub>dc</sub>
		LFM550M150			20	
		LFM550M240			32	
		LFM550M280			35	
		LFM550M300			35	
		LFM550M360			45	
		LFM550M480			55	
		LFM550M540			60	
Over Current Protection	Auto recovery (output is rated load)	All	120	140	160	%
Short Circuit Protection	Auto recovery	All				
Over Temperature Protection	Auto recovery	All				
Output Ripple and Noise	1. Add a 0.1uF ceramic capacitor and a 10uF aluminum electrolytic capacitor to output 2. Oscilloscope is 20MHz band width 3. Ambient Temperature=25°C	LFM550M120			120	mV
		LFM550M150			150	
		LFM550M240			200	
		LFM550M280			200	
		LFM550M300			200	
		LFM550M360			200	
		LFM550M480			200	
		LFM550M540			200	
Load Capacitance	1. V <sub>in</sub> =115V <sub>ac</sub> and 230V <sub>ac</sub> 2. Output is max. load 3. Ambient temperature=25°C	LFM550M120			27200	uF
		LFM550M150			22400	
		LFM550M240			14100	
		LFM550M280			11600	
		LFM550M300			10600	
		LFM550M360			9020	
		LFM550M480			7200	
		LFM550M540			6000	
Efficiency	1. Input Voltage is 230V <sub>ac</sub> 2. Output is rated load 3. Ambient temperature=25°C	LFM550M120		92		%
		LFM550M150		93		
		LFM550M240		93		
		LFM550M280		93		
		LFM550M300		93		
		LFM550M360		94		
		LFM550M480		94		
		LFM550M540		94		

## ISOLATION CHARACTERISTICS

PARAMETER	NOTES and CONDITIONS	Device	Min.	Typ.	Max.	Units
Input to Output	1 Minute (without dielectric breakdown)	All			4250	V <sub>ac</sub>
Input to Earth (Ground)	1 Minute (without dielectric breakdown)	All			2000	V <sub>ac</sub>
Output to Earth (Ground)	1 Minute (without dielectric breakdown)	All			2000	V <sub>ac</sub>
Isolation Resistance	Input to output	All	100			MΩ

## FEATURE CHARACTERISTICS

PARAMETER	NOTES and CONDITIONS	Device	Min.	Typ.	Max.	Units
Switching Frequency		All		65		kHz



# LFM550M Series

## GENERAL SPECIFICATIONS

PARAMETER	NOTES and CONDITIONS	Device	Min.	Typ.	Max.	Units
MTBF	I <sub>o</sub> =100%; T <sub>a</sub> =25°C per MIL-HDBK-217F I <sub>o</sub> =100%; T <sub>a</sub> =25°C per Telcordia SR332	All	400		1300	k hours
Life Time (Detail refer to Application Note)	Conduction cooling @75% Load, 40°C Fan cooling @75% Load, 40°C	All		97 150		k hours
Humidity	Non-condensing	All			93	% RH
Shock	Meet MIL-STD-810F Table 516.5, Table 516.5-I 10ms, each axis 3 times(±X · ±Y · ±Z axis)	All		75		g
Vibration	Meet MIL-STD-810F Table 514.5C-VIII, 15~2000Hz, X · Y · Z axis, 1 hour (each axis),. Total 3 hrs.	All		4		g
Weight	Baseplate versions Covered versions	LFM550MXXXB LFM550MXXXC		380 535		grams
Dimensions	Baseplate versions Covered versions	LFM550MXXXB LFM550MXXXC	5.00x3.00x1.00 Inches (127.0x76.2x25.4 mm) 5.09x3.29x1.00 Inches (129.4x83.5x25.4 mm)			
<b>Safety</b>	Class I, Class II ANSI/AAMI ES 60601-1, IEC 60601-1, EN 60601-1					Ed. 3.2
	Class I, IEC/EN/UL 62368-1					Ed. 3.0
<b>EMC Emission</b>	EN 55011 Class B, IEC/EN 61000-3-2, EN 61000-3-3, 47 CFR FCC Part 18 EN 55032, EN 61000-6-4, EN 61204-3, EN 61000-3-2, EN 61000-3-3, 47 CFR FCC Part 15					
Conducted Disturbance	EN 55011, EN 55032, 47 CFR FCC Part 18 & Part 15					Class B
Radiated Disturbance	EN 55011, 47 CFR FCC Part 18 (Class II Only Meets Class A) EN 55032, 47 CFR FCC Part 15					Class B
Harmonic Current Emissions	IEC/EN 61000-3-2					Class A, C, D
Voltage Fluctuations & Flicker	EN 61000-3-3					Criterion A
<b>EMC Immunity</b>	EN 60601-1-2, IEC/EN 61000-4-2, 3, 4, 5, 6, 8, 11					Ed 4.1
	EN 55035, EN 61000-6-2, EN 61204-3					
Electrostatic Discharge (ESD)	IEC 61000-4-2, Level 4: Air Discharge: ±15kV, Contact Discharge: ±8kV					Criterion A
Radio-Frequency, Continuous Radiated Disturbance	IEC/EN 61000-4-3, Level 3: 80~2700MHz, 10V/m					Criterion A
Electrical Fast Transient (EFT)	EN 61000-4-4, Level 3: ±2KV					Criterion A
Surge	EN 61000-4-5, Level 4: L-N: ±2kV, L-E (Ground): ±4kV					Criterion A
Conducted Disturbances, Induced by RF Fields	EN 61000-4-6, Level 3: 0.15~80MHz, 10V					Criterion A
Power Frequency Magnetic Field	EN 61000-4-8, Level 4: 30A/m					Criterion A
Voltage Dips	IEC/EN 61000-4-11, Dip: 30% Reduction IEC/EN 61000-4-11, Dip >95% Reduction					Criterion A
Voltage Interruptions	IEC/EN 61000-4-11, >95% Reduction					Criterion B
Application Note Link						<a href="#">LFM550M Series App Notes</a>



# LFM550M Series

## CHARACTERISTIC CURVE

### Power Derating Curve

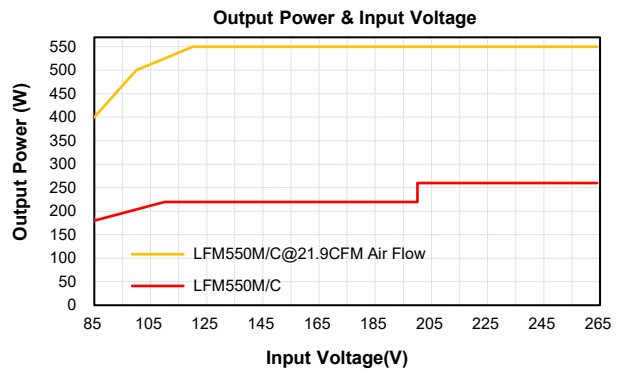
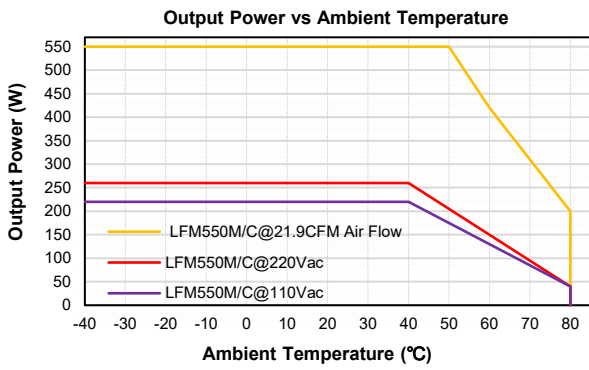
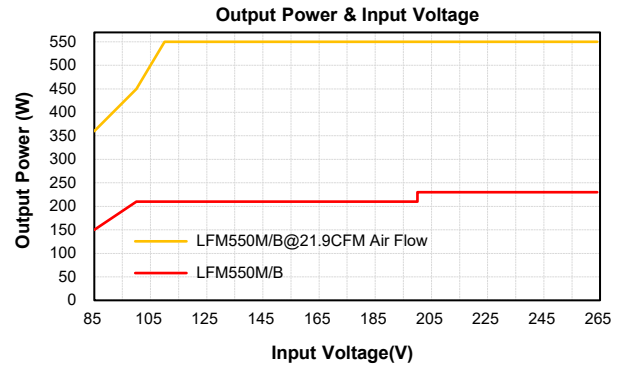
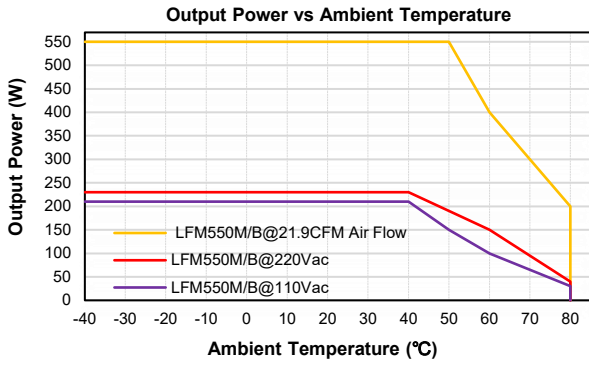



# LFM550M Series

## Conduction Convection with External Baseplate (38.1cmx38.1cmx0.2cm)

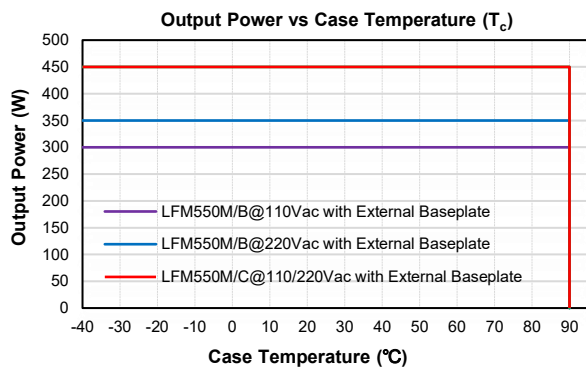
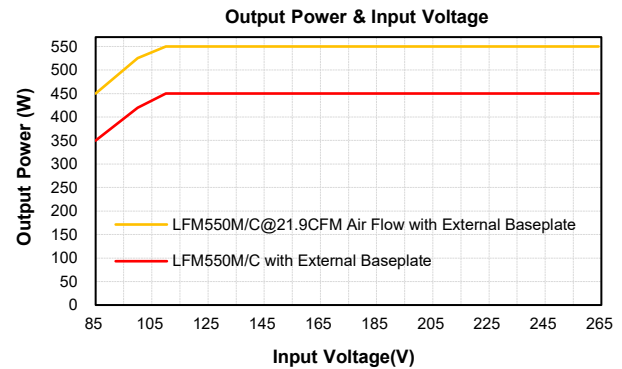
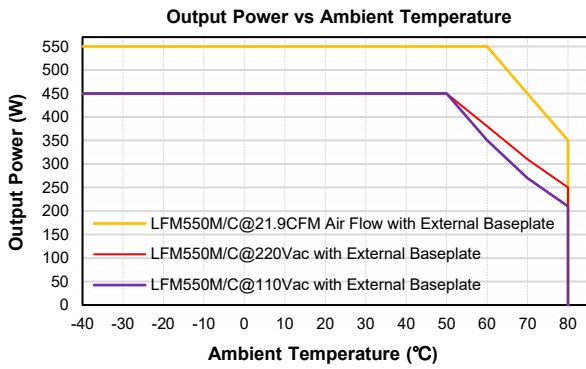
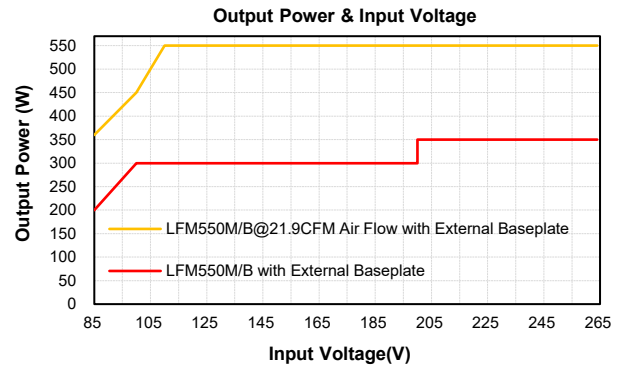
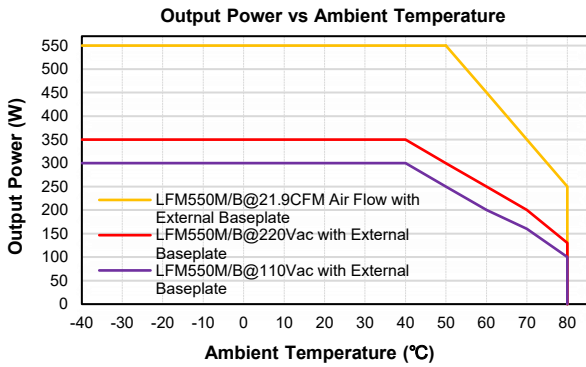



# LFM550M Series

## Performance Data

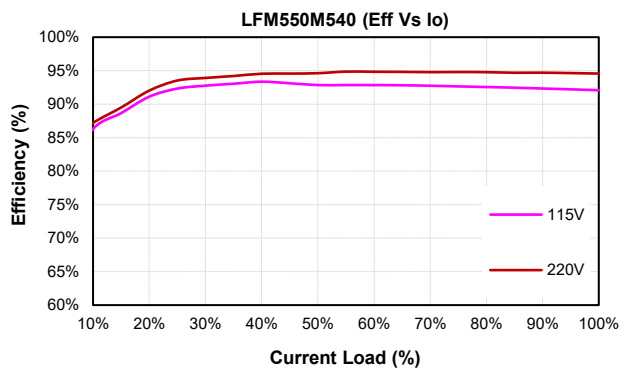
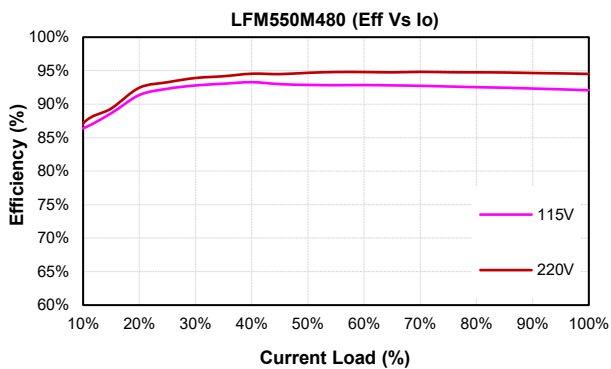
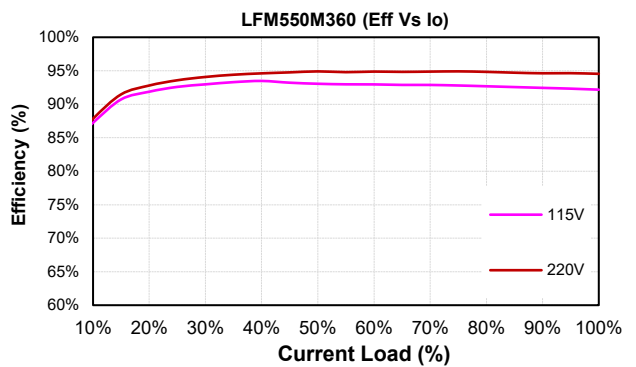
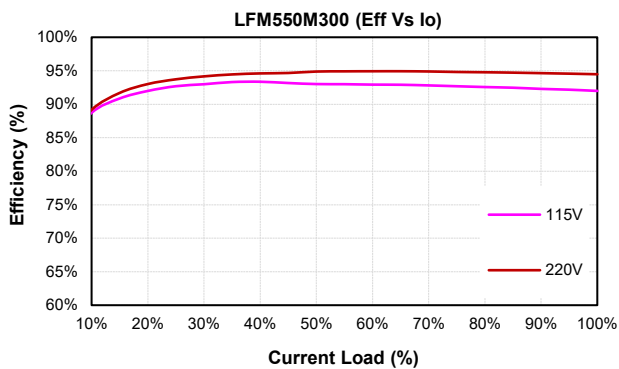
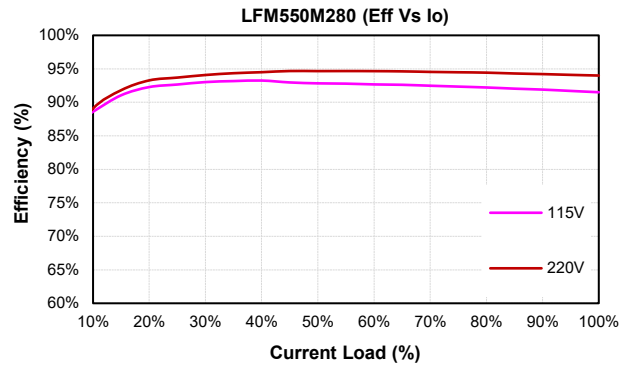
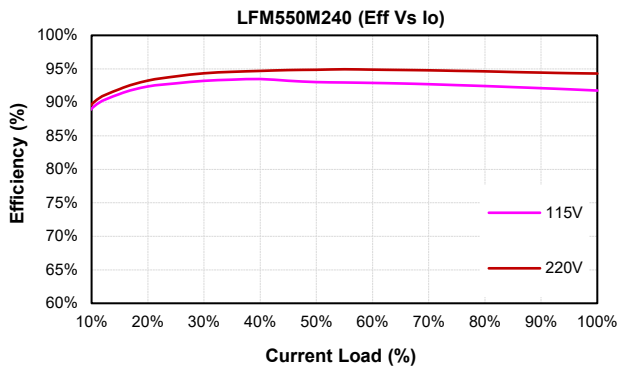
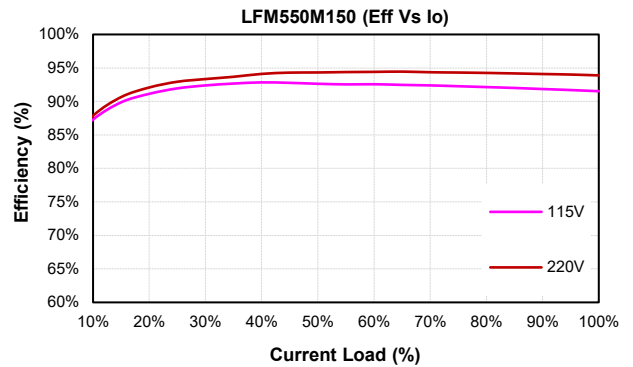
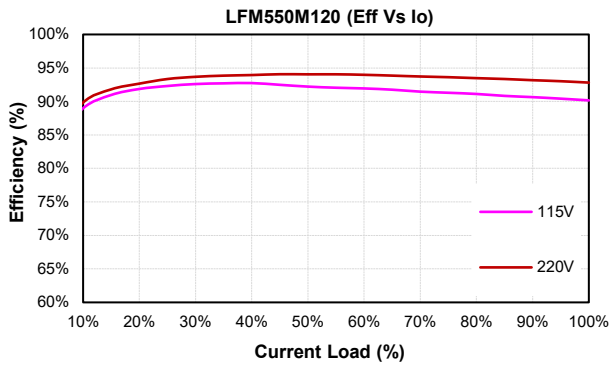



# LFM550M Series

## MECHANICAL SPECIFICATION

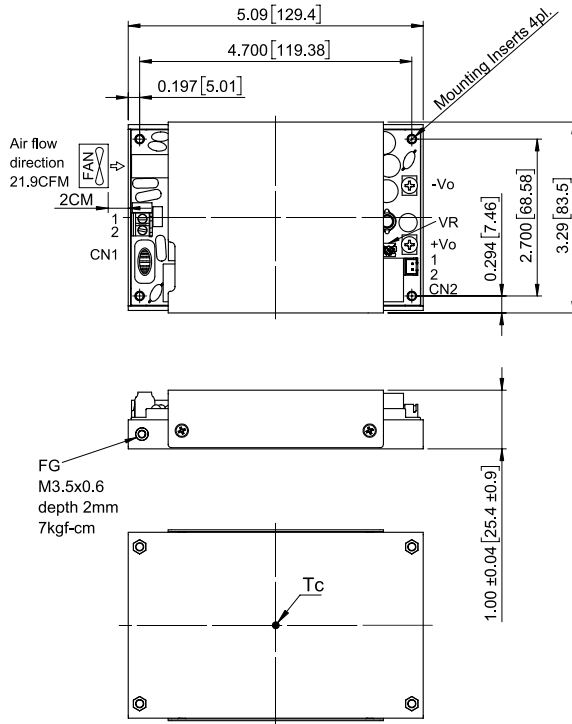

### LFM550MXXXC LFM550MXXXC-C0

All Dimensions in Inches[mm]  
Tolerance Inches: x.xx=±0.03, x.xxx=±0.020  
Millimeters: x.x=±0.7, x.xx=±0.50

AC Input Connector(CN1):ECE ETB22

Pin	Function	Mating Wire Range
1	ACL	14~16 AWG
2	ACN	

DC Output Connector(CN2):TKP 8822-02-NHB or equivalent

Pin	Function	Mating Housing	Terminal
1	Rs+	JST XHP-2 or equivalent	JST SXH-001T-P0.6N or equivalent
2	Rs-		

DC Output Connector:KANG YANG PCB-58M4

Function	The screw locked torque
+Vo	M4 7kgf-cm
-Vo	

Mounting Inserts

Series	Option
Blank	∅3.2 Through depth 10.5mm
-C0	M3x0.5 Threaded depth 10.5mm

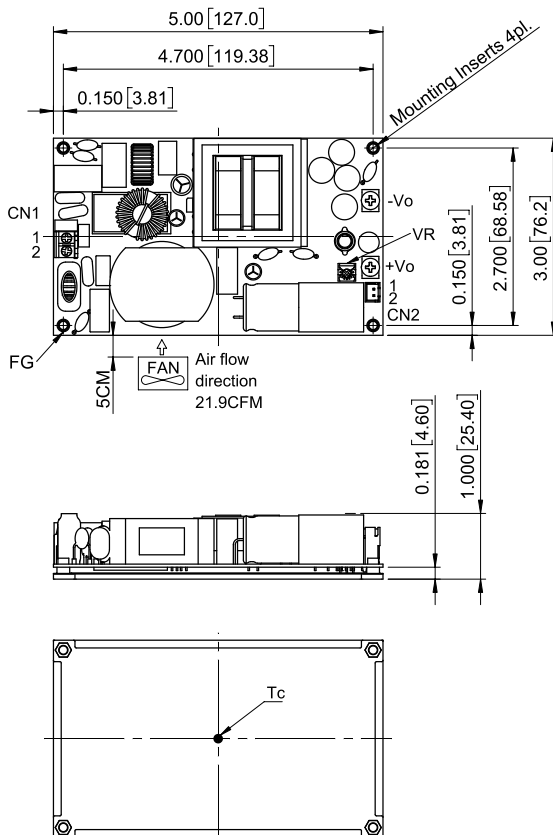

### LFM550MXXXB LFM550MXXXB-C0

All Dimensions in Inches[mm]  
Tolerance Inches: x.xx=±0.03, x.xxx=±0.020  
Millimeters: x.x=±0.7, x.xx=±0.50

AC Input Connector(CN1):ECE ETB22

Pin	Function	Mating Wire Range
1	ACL	14~16 AWG
2	ACN	

DC Output Connector(CN2):TKP 8822-02-NHB or equivalent

Pin	Function	Mating Housing	Terminal
1	Rs+	JST XHP-2 or equivalent	JST SXH-001T-P0.6N or equivalent
2	Rs-		

DC Output Connector:KANG YANG PCB-58M4

Function	The screw locked torque
+Vo	M4 7kgf-cm
-Vo	

Mounting Inserts

Series	Option
Blank	∅3.2 Through depth 8.1mm
-C0	M3x0.5 Threaded depth 8.1mm

CINCON Electronics Co. Ltd.  
Add: 14F, No. 306, Sec.4, Hsin Yi Rd., Taipei, Taiwan  
Tel: 886-2-27086210  
Fax: 886-2-27029852  
E-mail: [sales@cincon.com](mailto:sales@cincon.com)  
Web: [www.cincon.com](http://www.cincon.com)

***Authorised, valued-added distributor***

Australia & New Zealand



**Powerbox Australia Pty Ltd**

Sydney Head Office  
4 Beaumont Road,  
Mt Kuring-Gai, NSW 2080  
Australia

 1800 251 380

 sales@powerbox.com.au

 [powerbox.com.au](http://powerbox.com.au)

**Powerbox Pacific Ltd**

New Zealand Sales Office  
1a Henry Rose Place,  
Albany, Auckland  
New Zealand 0632

 09 4158 320

 sales@powerbox.co.nz

 [powerbox.co.nz](http://powerbox.co.nz)