



LFM420S SERIES 420 WATT AC-DC POWER SUPPLY WITH PFC

Features

- Universal Input Range 85~264Vac
- High Efficiency up to 94.5%
- Class I
- 25.4mm Low Profile Package
- No Load Input Power Consumption <0.5W
- No Load Input Power Consumption<0.6W for 54V
- Approval IEC/EN/UL 62368-1 Ed 3.0
- Approval EN55032 and CISPR/FCC Class B
- Meets IEC/EN 60335-1
- Operating Altitude 5000m
- Continuous Short Circuit Protection
- Over Voltage Protection
- Over Temperature Protection
- High Power Density 28.0 W/Inches³
- Active PFC Function
- Over Voltage Category OVC II & OVC III
- Constant Current



MODEL NUMBER	OUTPUT VOLTAGE	OUTPUT CURRENT			RIPPLE & NOISE NOTE1	VOLTAGE ACCURACY NOTE2	VOLTAGE ADJ. RANGE	LINE REGULATION NOTE3	LOAD REGULATION NOTE4	% EFF. (Typ.) NOTE5
		With Fan NOTE6	With Conduction Cooling NOTE7							
			Baseplate	Cover						
LFM420S120	12 V	35.00 A	26.25 A	29.17 A	120 mV	±1%	11.4-12.6 V	±0.5%	±1%	92.5%
LFM420S150	15 V	28.00 A	21.00 A	23.33 A	150 mV	±1%	14.25-15.75 V	±0.5%	±1%	93.0%
LFM420S240	24 V	17.50 A	13.13 A	14.58 A	240 mV	±1%	22.8-25.2 V	±0.5%	±1%	94.0%
LFM420S280	28 V	15.00 A	11.25 A	12.50 A	280 mV	±1%	28-29.4 V	±0.5%	±1%	94.0%
LFM420S300	30 V	14.00 A	10.50 A	11.67 A	300 mV	±1%	28.5-31.5 V	±0.5%	±1%	94.0%
LFM420S360	36 V	11.67 A	8.75 A	9.72 A	360 mV	±1%	34.2-37.8 V	±0.5%	±1%	94.0%
LFM420S480	48 V	8.75 A	6.56 A	7.29 A	480 mV	±1%	45.6-50.4 V	±0.5%	±1%	94.0%
LFM420S540	54 V	7.78 A	5.83 A	6.48 A	540 mV	±1%	51.3-55.0 V	±0.5%	±1%	94.5%

Note:

1. Add a 0.1uF ceramic capacitor and a 10uF E.L. capacitor to output for ripple & noise measuring @20MHz BW.
2. Voltage accuracy is set at full load and 25°C Ta.
3. Line regulation is measured from high line to low line with rated load.
4. Load regulation is measured from full load to 10% rated load.
5. Typical efficiency at 230 Vac and full load at 25°C.
6. Forced air convection with 21.9CFM above 100V_{ac}.
7. Conduction convection with external baseplate,24.8*48.0cm with min.0.12cm thick @115V_{ac}.



LFM420S Series

PART NUMBER

Series	Number of Outputs	Nominal Output Voltage	Type	Mounting Inserts
LFM420	O	XXX	X	-YZ
LFM420	S : Single	120 : 12V 150 : 15V 240 : 24V 280 : 28V 300 : 30V 360 : 36V 480 : 48V 540 : 54V	B : With Baseplate C : With Cover	Blank: Through Hole C0: Threaded Hole

Part Number Example:

LFM420S120C: With Cover, 420W, 12Vdc Output



LFM420S Series

TECHNICAL SPECIFICATIONS

(All specifications are typical at nominal input, full load at 25°C unless otherwise noted.)

ABSOLUTE MAXIMUM RATINGS

PARAMETER	NOTES and CONDITIONS	Device	Min.	Typ.	Max.	Units
Input Voltage	Safety approvals only to the AC input	All	85		264	V _{ac}
	No safety approvals		120		370	V _{dc}
Operating Temperature	See derating curve	All	-40		80	°C
Operating Case Temperature	At the center of base plate (T _c = Case temperature)	All	-40		85	°C
Storage Temperature		All	-40		85	°C
Operating Altitude	IEC/EN/UL 62368 OVC II	All			5000	m
	IEC/EN/UL 62368 OVC III				2000	m

INPUT CHARACTERISTICS

PARAMETER	NOTES and CONDITIONS	Device	Min.	Typ.	Max.	Units
Operating Voltage Range		All	100		240	V _{ac}
Input Frequency Range	No safety approvals. Some specifications are not meet, such as Leakage Current and No Load Input Power Consumption	All	47		63	Hz
				400		
Maximum Input Current	100% Load, V _{in} =100V _{ac}	All			6	A
Leakage Current	@47-63Hz	All			0.3	mA
Inrush Current	V _{in} =240V _{ac} , Cold start at 25°C	All		30		A
Under Voltage Protection		All	65		75	V _{ac}
Power Factor	115V _{ac} @ Full load, 47-63Hz	All		0.98		
	230V _{ac} @ Full load, 47-63Hz			0.95		
	115V _{ac} @ Full load, 400Hz Input Frequency 400HZ No safety approvals			0.93		

OUTPUT CHARACTERISTICS

PARAMETER	NOTES and CONDITIONS	Device	Min.	Typ.	Max.	Units
Output Voltage Set Point	V _{in} =Nominal V _{in} , I _o =I _o max., T _c =25°C	LFM420S120	11.88	12	12.12	V _{dc}
		LFM420S150	14.85	15	15.15	
		LFM420S240	23.76	24	24.24	
		LFM420S280	27.72	28	28.28	
		LFM420S300	29.70	30	30.30	
		LFM420S360	35.64	36	36.36	
		LFM420S480	47.52	48	48.48	
		LFM420S540	53.46	54	54.54	
Operating Output Current Range	V _{in} =85V _{ac} ~264V _{ac} , see derating curve	LFM420S120			35.00A	A
		LFM420S150			28.00A	
		LFM420S240			17.50A	
		LFM420S280			15.00A	
		LFM420S300			14.00A	
		LFM420S360			11.67A	
		LFM420S480			8.75A	
		LFM420S540			7.78A	
Holdup Time	V _{in} =115Vac load:350W Ambient temperature=25°C	All		12		ms
	V _{in} =115Vac Load:420W Ambient temperature=25°C			8		
Output Voltage Regulation						
Load Regulation	10% Load to full load	All			±1.0	%



LFM420S Series

PARAMETER	NOTES and CONDITIONS	Device	Min.	Typ.	Max.	Units
Line Regulation	V_{in} =High line to low line	All			±0.5	%
Output Voltage Adjustment	$P_o \leq$ max. rated power, $I_o \leq I_o$ max.	LFM420S280	0		+5	%
	$P_o \leq$ max. rated power, $I_o \leq I_o$ max.	LFM420S540	-5		+2	%
	$P_o \leq$ max. rated power, $I_o \leq I_o$ max.	Others	-5		+5	%
Over Voltage Protection	Latch off (reset after about one minute after the input is turned off)	LFM420S120		16		V_{dc}
		LFM420S150		20		
		LFM420S240		30		
		LFM420S280		35		
		LFM420S300		35		
		LFM420S360		50		
		LFM420S480		63		
Over Current Protection	Constant current, auto recovery (see application note)	All	110		180	%
Short Circuit Protection	Auto recovery	All				
Over Temperature Protection	Auto recovery If conduction convection with external baseplate is used or the recommended temperature curve is exceeded, the T_c temperature must be maintained <85°C	All				
Output Ripple and Noise	1. Add a 0.1uF ceramic capacitor and a 10uF aluminum electrolytic capacitor to output 2. Oscilloscope is 20MHz Band Width 3. Ambient Temperature=25°C	LFM420S120			120	mV
		LFM420S150			150	
		LFM420S240			240	
		LFM420S280			280	
		LFM420S300			300	
		LFM420S360			360	
		LFM420S480			480	
Load Capacitance	1. V_{in} =115V _{ac} and 230V _{ac} 2. Output is max. load 3. Ambient temperature=25°C	LFM420S120			29100	uF
		LFM420S150			23300	
		LFM420S240			14500	
		LFM420S280			12500	
		LFM420S300			11600	
		LFM420S360			9700	
		LFM420S480			7200	
Efficiency	1. Input Voltage is 230V _{ac} 2. Output is rated load 3. Ambient temperature=25°C	LFM420S120		92.5%		%
		LFM420S150		93.0%		
		LFM420S240		94.0%		
		LFM420S280		94.0%		
		LFM420S300		94.0%		
		LFM420S360		94.0%		
		LFM420S480		94.0%		
LFM420S540		94.5%				

ISOLATION CHARACTERISTICS

PARAMETER	NOTES and CONDITIONS	Device	Min.	Typ.	Max.	Units
Input to Output	1 Minute (without dielectric breakdown)	All			4250	V _{ac}
Input to Earth (Ground)	1 Minute (without dielectric breakdown)	All			2000	V _{ac}
Output to Earth (Ground)	1 Minute (without dielectric breakdown)	All			2000	V _{ac}
Isolation Resistance	Input to Output	All	100			MΩ



LFM420S Series

FEATURE CHARACTERISTICS

PARAMETER	NOTES and CONDITIONS	Device	Min.	Typ.	Max.	Units
Switching Frequency	P_{out} =max. rated power	All		65		kHz

GENERAL SPECIFICATIONS

PARAMETER	NOTES and CONDITIONS	Device	Min.	Typ.	Max.	Units
MTBF	$I_o=100\%$; $T_a=25^\circ\text{C}$ per MIL-HDBK-217F $I_o=100\%$, $T_a=25^\circ\text{C}$, Telcordia SR332	All	1600	400		K hours
Life Time (Detail Refer to App. Note)	Conduction cooling @75% Load, 40°C Fan cooling @75% Load, 40°C	All		119 288		k hours
Humidity	Non-condensing	All			93	% RH
Shock	Meet MIL-STD-810F Table 516.5, Table 516.5-1 10ms, each axis 3 times($\pm X$ 、 $\pm Y$ 、 $\pm Z$ axis)	All		75		g
Vibration	Meet MIL-STD-810F Table 514.5C-VIII, 15~2000Hz, X、Y、Z axis, 1 hour (each axis), Total 3 hrs.	All		4		g
Weight	Baseplate versions Covered versions	All		350 470		g
Dimensions	Baseplate versions	All	5.00x3.00x1.00 Inches (127x76.2x25.40mm)			
	Covered versions		5.09x3.29x1.00 Inches (129.4x83.5x25.4mm)			
Safety	Class I, IEC/EN/UL 62368-1					Ed. 3.0
EMC Emission	EN 55032 (Class B), EN 61000-6-3, EN 61000-6-4, EN 61204-3, EN 61000-3-2, EN 61000-3-3, 47 CFR FCC Part 15 Subpart B					Class B
Conducted Disturbance	EN 55032, 47 CFR FCC Part 15 Subpart B (Class B)					Class B
Radiated Disturbance	EN 55032, 47 CFR FCC Part 15 Subpart B (Class B)					Class B
Harmonic Current Emissions	EN 61000-3-2					Class A, C, D
Voltage Fluctuations & Flicker	EN 61000-3-3					
EMC Immunity	EN 55035, EN 61000-6-1, EN 61000-6-2, EN 61204-3					
Electrostatic Discharge (ESD)	IEC 61000-4-2, Level 3: Air Discharge: $\pm 8\text{kV}$, Contact Discharge: $\pm 4\text{kV}$					Criterion A
Radio-Frequency, Continuous Radiated Disturbance	IEC 61000-4-3, Level 3: 80~1000MHz, 10V/m					Criterion A
Electrical Fast Transient (EFT)	IEC 61000-4-4, Level 3: $\pm 2\text{kV}$					Criterion A
Surge	IEC 61000-4-5, Level 4: L-N: $\pm 2\text{kV}$, L-E (Ground): $\pm 4\text{kV}$					Criterion A
Conducted Disturbances, Induced by RF Fields	IEC 61000-4-6, Level 3: 0.15-80MHz, 10V					Criterion A
Power Frequency Magnetic Field	IEC 61000-4-8, Level 4: 50-60Hz, 30A/m					Criterion A
Voltage Dips	IEC 61000-4-11, Dip: 30% Reduction IEC 61000-4-11, Dip >95% Reduction					Criterion A
Voltage Interruptions	IEC 61000-4-11, >95% Reduction					Criterion B
Application Note Link						LFM420S Series App Notes



CHARACTERISTIC CURVE

Power Derating Curve

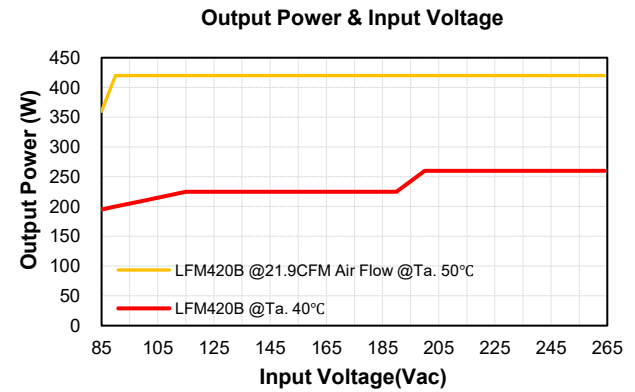
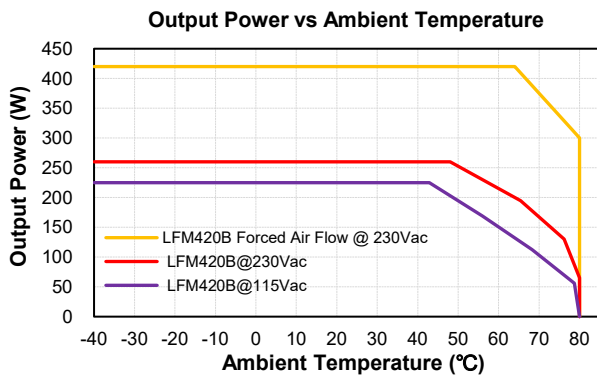
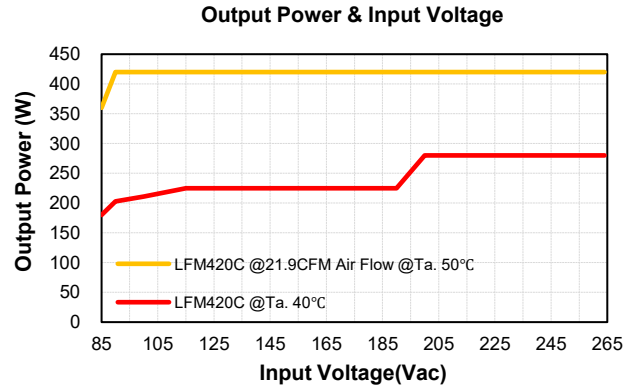
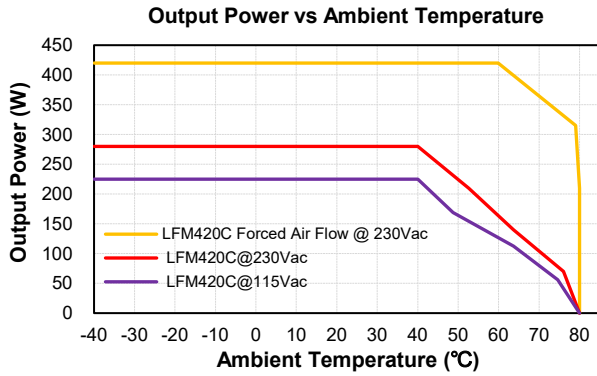

Conduction Convection with External Baseplate (24.8cmx48cmx0.12cm)

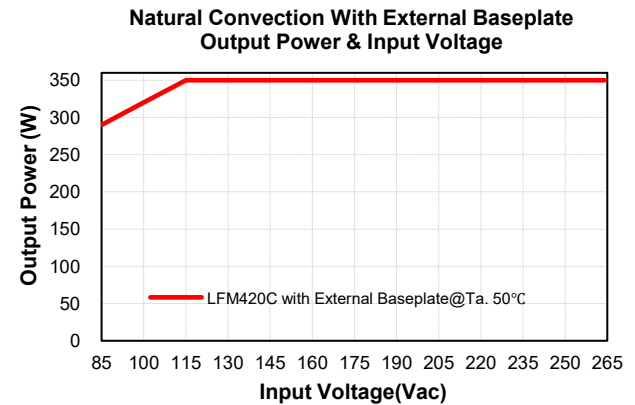
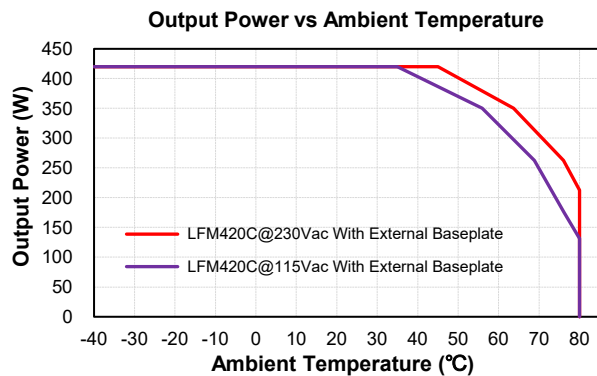



LFM420S Series

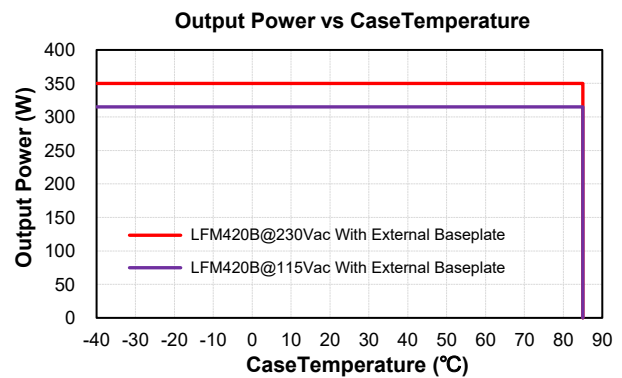
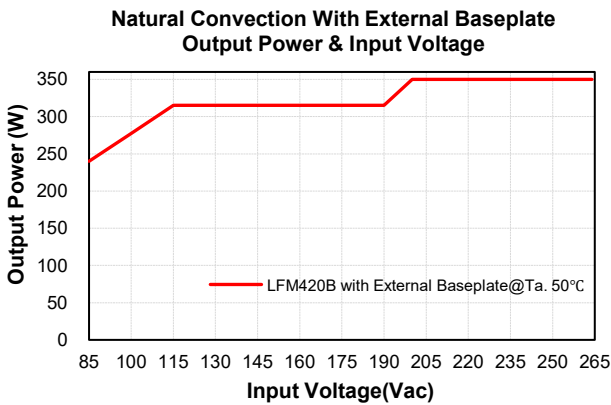
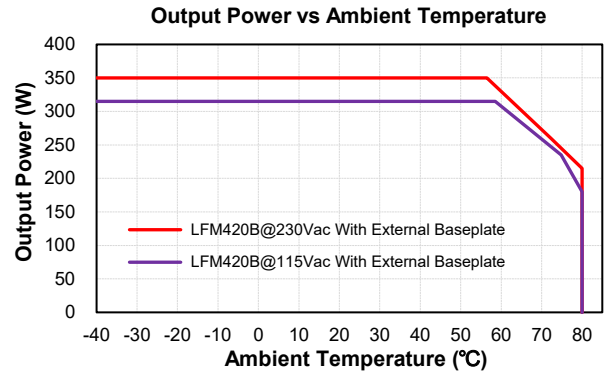
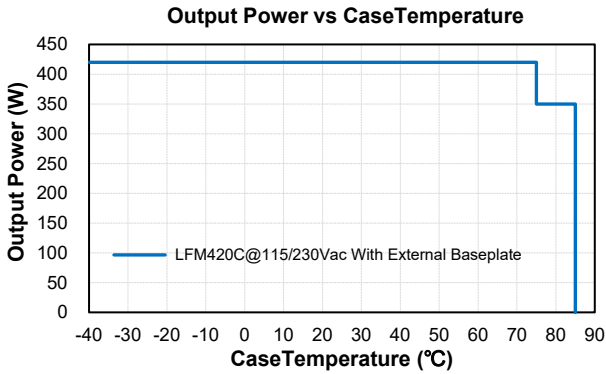

Performance Data

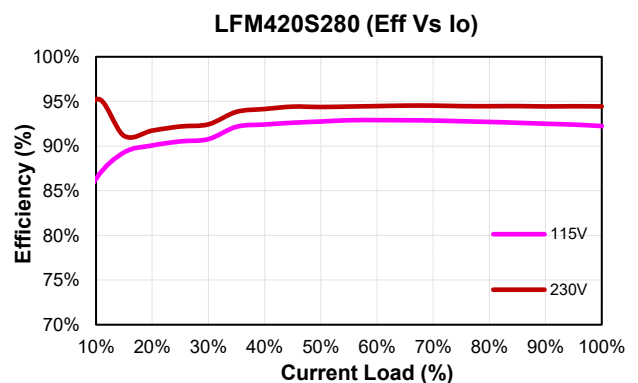
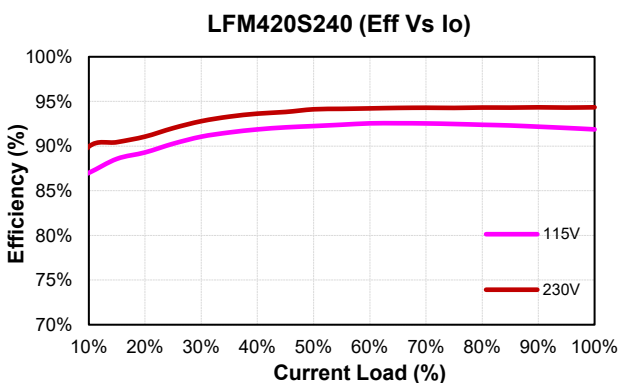
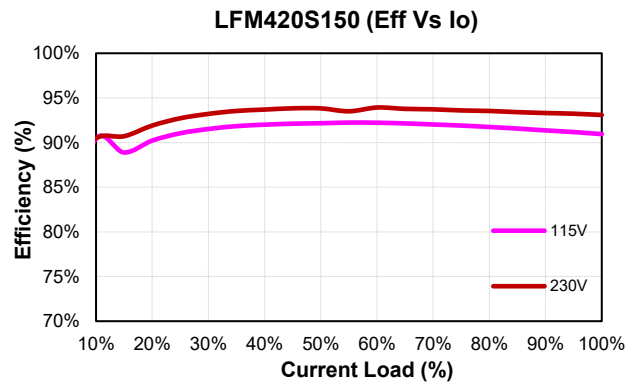
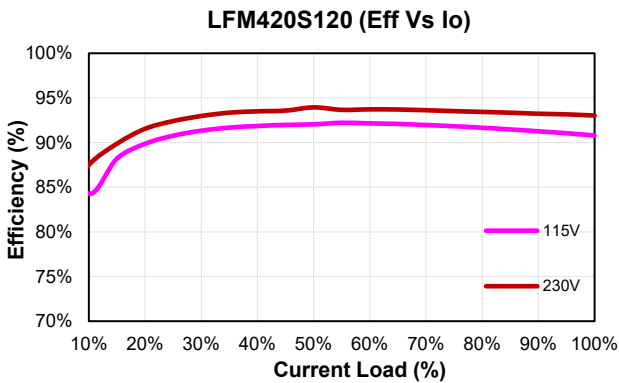



LFM420S Series

LFM420S300 (Eff Vs Io)

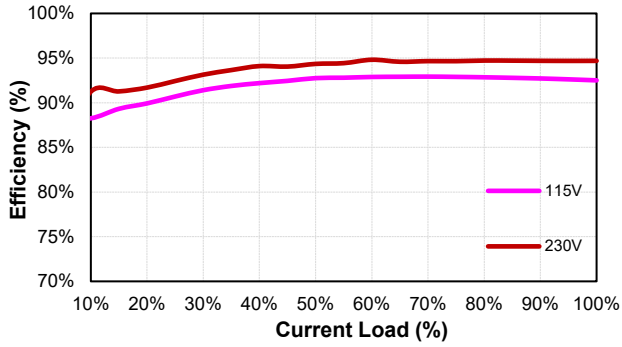

LFM420S360 (Eff Vs Io)

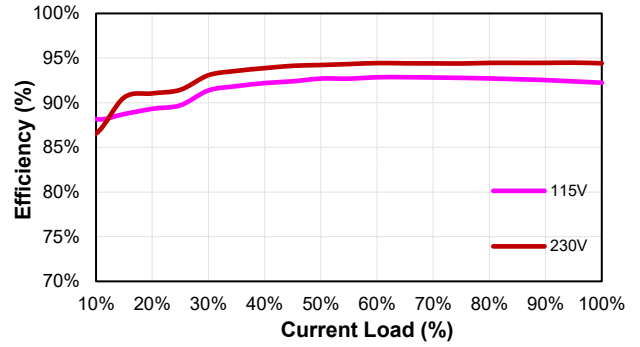

LFM420S480 (Eff Vs Io)

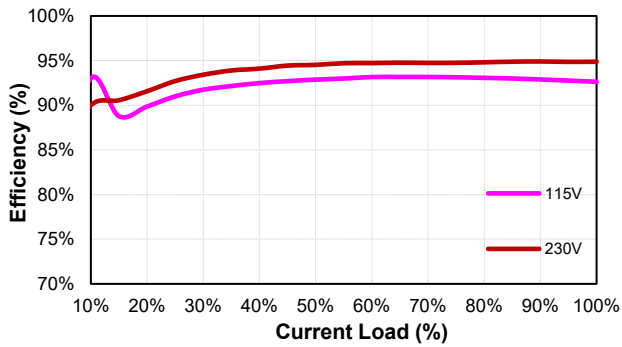

LFM420S540 (Eff Vs Io)

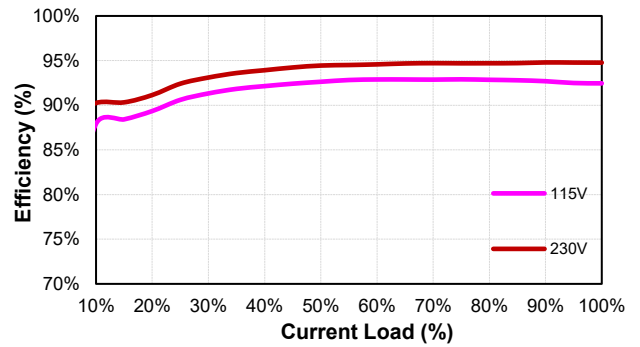



LFM420S Series

MECHANICAL SPECIFICATION

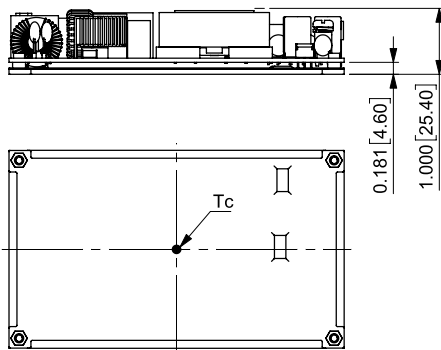
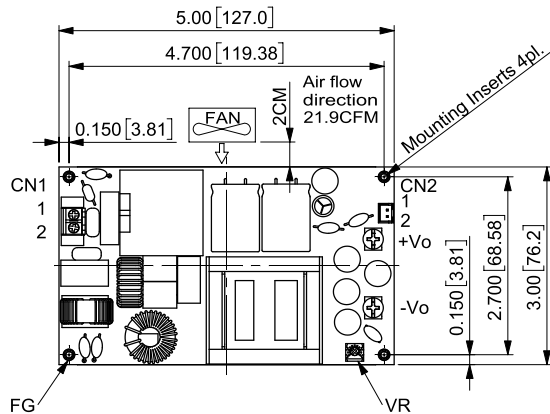
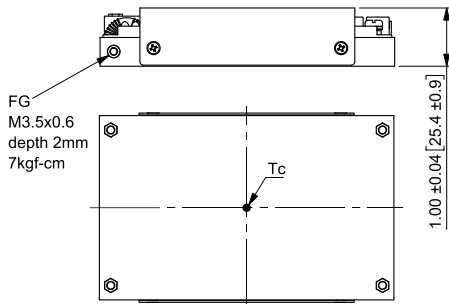
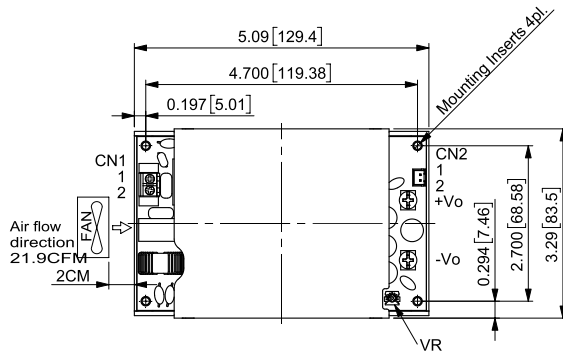

LFM420SXXXC LFM420SXXXC-C0

All Dimensions in Inches[mm]
Tolerance Inches: x.xx=±0.03, x.xxx=±0.020
Millimeters: x.x=±0.7, x.xx=±0.50

AC Input Connector(CN1):ECE ETB22

Pin	Function	Mating Wire Range
1	ACL	14~18 AWG
2	ACN	

DC Output Connector(CN2):TKP 8822-02-NHB or equivalent

Pin	Function	Mating Housing	Terminal
1	Rs+	JST XHP-2 or equivalent	JST SXH-001T-P0.6N or equivalent
2	Rs-		

DC Output Connector:KANG YANG PCB-58M4

Function	The screw locked torque
+Vo	M4 7kgf-cm
-Vo	

Mounting Inserts

Series	Option
Blank	Ø3.2 Through depth 10.5mm
-C0	M3x0.5 Threaded depth 10.5mm

LFM420SXXXB LFM420SXXXB-C0

All Dimensions in Inches[mm]
Tolerance Inches: x.xx=±0.03, x.xxx=±0.020
Millimeters: x.x=±0.7, x.xx=±0.50

AC Input Connector(CN1):ECE ETB22

Pin	Function	Mating Wire Range
1	ACL	14~18 AWG
2	ACN	

DC Output Connector(CN2):TKP 8822-02-NHB or equivalent

Pin	Function	Mating Housing	Terminal
1	Rs+	JST XHP-2 or equivalent	JST SXH-001T-P0.6N or equivalent
2	Rs-		

DC Output Connector:KANG YANG PCB-58M4

Function	The screw locked torque
+Vo	M4 7kgf-cm
-Vo	

Mounting Inserts

Series	Option
Blank	Ø3.2 Through depth 8.1mm
-C0	M3x0.5 Threaded depth 8.1mm

CINCON Electronics Co. Ltd.
Add: 14F, No. 306, Sec.4, Hsin Yi Rd., Taipei, Taiwan
Tel: 886-2-27086210
Fax: 886-2-27029852
E-mail: sales@cincon.com.tw
Web: www.cincon.com

Authorised, valued-added distributor

Australia & New Zealand



Powerbox Australia Pty Ltd

Sydney Head Office
4 Beaumont Road,
Mt Kuring-Gai, NSW 2080
Australia



1800 251 380



sales@powerbox.com.au



powerbox.com.au

Powerbox Pacific Ltd

New Zealand Sales Office
1a Henry Rose Place,
Albany, Auckland
New Zealand 0632



09 4158 320



sales@powerbox.co.nz



powerbox.co.nz