

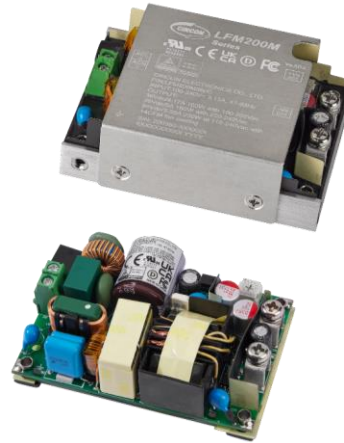

LFM200M SERIES 200 WATT MEDICAL AC-DC POWER SUPPLY WITH PFC

Features

- Universal Input Range 85~264Vac
- High Efficiency up to 94%
- Class I & Class II
- 25.4mm Low Profile Package
- No Load Input Power Consumption<0.3W
- 48V, 54V No Load Input Power Consumption<0.4W
- Approval Safety IEC/EN/UL 60601-1 2 MOPP
- Approval Safety IEC/EN/UL 62368-1
- Meets IEC/EN 60335-1
- Operating Altitude 5000m
- Continuous Short Circuit Protection
- Over Voltage Protection
- Over Temperature Protection
- High Power Density 32.89W/Inches³
- Active PFC Function



MODEL NUMBER	OUTPUT VOLTAGE	OUTPUT CURRENT			RIPPLE & NOISE NOTE1	VOLTAGE ACCURACY NOTE2	VOLTAGE ADJ. RANGE	LINE REGULATION NOTE3	LOAD REGULATION NOTE4	% EFF. (Typ.) NOTE5
		With Fan NOTE6	With Conduction Cooling NOTE7							
			Baseplate	Cover						
LFM200M120	12 V	16.67 A	10.83 A	14.17 A	150 mV	±1%	11.4-12.6 V	±0.2%	±0.5%	92%
LFM200M150	15 V	13.33 A	8.66 A	11.33 A	150 mV	±1%	14.25-15.75 V	±0.2%	±0.5%	92%
LFM200M240	24 V	8.33 A	5.41 A	7.08 A	200 mV	±1%	22.8-25.2 V	±0.2%	±0.5%	94%
LFM200M280	28 V	7.14 A	4.64 A	6.07 A	200 mV	±1%	26.6-29.4 V	±0.2%	±0.5%	93%
LFM200M300	30 V	6.66 A	4.33 A	5.67 A	200 mV	±1%	28.5-31.5 V	±0.2%	±0.5%	93%
LFM200M360	36 V	5.55 A	3.61 A	4.72 A	200 mV	±1%	34.2-37.8 V	±0.2%	±0.5%	94%
LFM200M480	48 V	4.16 A	2.71 A	3.54 A	200 mV	±1%	45.6-50.4 V	±0.2%	±0.5%	94%
LFM200M540	54 V	3.7 A	2.41 A	3.15 A	200 mV	±1%	51.3-56.7 V	±0.2%	±0.5%	93%

Note:

1. Add a 0.1uF ceramic capacitor and a 10uF E.L. capacitor to output for ripple & noise measuring @20MHz BW.
2. Voltage accuracy is set at full load.
3. Line regulation is measured from 100Vac to 240Vac with full load.
4. Load regulation is measured from 10% to 100% full load.
5. Typical efficiency at 230 V_{ac} and full load at 25°C.
6. Forced air convection with 14CFM above 110V_{ac}.
7. With addition cooling conduction plate, 17.78 by 17.78 cm with min. 0.2 cm thick, as below.



LFM200M Series

PART NUMBER

Series	Number of Outputs	Nominal Output Voltage	Type	Mounting Inserts
LFM200	O	XXX	X	-YZ
LFM200	M : Medical	120 : 12V 150 : 15V 240 : 24V 280 : 28V 300 : 30V 360 : 36V 480 : 48V 540 : 54V	B : With Baseplate C : With Cover	Blank : Through Hole C0 : Threaded Hole

Part Number Example:

LFM200M120C-C0: With Cover 200W, Medical 12Vdc Output, Threaded Hole

LFM200M240B: With Baseplate 200W, Medical 24Vdc Output, Through Hole



LFM200M Series

TECHNICAL SPECIFICATIONS

(All specifications are typical at nominal input, full load at 25°C unless otherwise noted.)

ABSOLUTE MAXIMUM RATINGS

PARAMETER	NOTES and CONDITIONS	Device	Min.	Typ.	Max.	Units
Input Voltage	Safety approvals only to the AC input	All	85		264	V _{ac}
				115		370
Operating Temperature	See derating curve	All	-40		80	°C
Operating Case Temperature	At the center of base plate (T _c = Case temperature)	All	-40		90	°C
Storage Temperature		All	-40		90	°C
Operating Altitude		All			5000	m

INPUT CHARACTERISTICS

PARAMETER	NOTES and CONDITIONS	Device	Min.	Typ.	Max.	Units
Operating Voltage Range		All	100		240	V _{ac}
Input Frequency Range		All	47		63	Hz
Maximum Input Current	100% Load, V _{in} =100V _{ac}	All			3.15	A
Leakage Current	Contact leakage current	All			100	uA
	Earth leakage current				300	
Inrush Current	V _{in} =240V _{ac} , Cold start @25°C	All			85	A
Power Factor	230V _{ac} @ Full load	All	0.96	0.98		

OUTPUT CHARACTERISTICS

PARAMETER	NOTES and CONDITIONS	Device	Min.	Typ.	Max.	Units
Output Voltage Set Point	V _{in} =Nominal V _{in} , I _o =I _o max., T _c =25°C	LFM200M120	11.88	12	12.12	V _{dc}
		LFM200M150	14.85	15	15.15	
		LFM200M240	23.76	24	24.24	
		LFM200M280	27.72	28	28.28	
		LFM200M300	29.7	30	30.3	
		LFM200M360	35.64	36	36.36	
		LFM200M480	47.52	48	48.48	
		LFM200M540	53.46	54	54.54	
Operating Output Current Range	V _{in} =85V _{ac} ~264V _{ac} , see derating curve	LFM200M120	0		16.67	A
		LFM200M150	0		13.33	
		LFM200M240	0		8.33	
		LFM200M280	0		7.14	
		LFM200M300	0		6.66	
		LFM200M360	0		5.55	
		LFM200M480	0		4.16	
		LFM200M540	0		3.7	
Holdup Time	V _{in} =115V _{ac}	All	10	12		ms
Output Voltage Regulation						
Load Regulation	10% Load to full load	All			±0.5	%
Line Regulation	V _{in} =High line to low line	All			±0.2	%
Output Voltage Adjustment	P _o ≤ max. rated power, I _o ≤ I _o max.	All	-5		+5	%



LFM200M Series

PARAMETER	NOTES and CONDITIONS	Device	Min.	Typ.	Max.	Units
Over Voltage Protection	Latch off (AC recycle to reset)	LFM200M120			16	V _{dc}
		LFM200M150			20	
		LFM200M240			32	
		LFM200M280			35	
		LFM200M300			35	
		LFM200M360			45	
		LFM200M480			55	
		LFM200M540			63	
Over Current Protection	Auto recovery (output is rated load)	All	120	145	165	%
Short Circuit Protection	Auto recovery	All				
Over Temperature Protection	Auto recovery	All				
Output Ripple and Noise	1. Add a 0.1uF ceramic capacitor and a 10uF aluminum electrolytic capacitor to output 2. Oscilloscope is 20MHz band width 3. Ambient Temperature=25°C	LFM200M120			150	mV
		LFM200M150			150	
		LFM200M240			200	
		LFM200M280			200	
		LFM200M300			200	
		LFM200M360			200	
		LFM200M480			200	
		LFM200M540			200	
Load Capacitance	1. V _{in} =115V _{ac} and 230V _{ac} 2. Output is max. load 3. Ambient temperature=25°C	LFM200M120			6800	uF
		LFM200M150			5360	
		LFM200M240			3440	
		LFM200M280			3440	
		LFM200M300			3220	
		LFM200M360			2680	
		LFM200M480			2000	
		LFM200M540			1560	
Efficiency	1. Input Voltage is 230V _{ac} 2. Output is rated load 3. Ambient temperature=25°C	LFM200M120		92		%
		LFM200M150		92		
		LFM200M240		94		
		LFM200M280		93		
		LFM200M300		93		
		LFM200M360		94		
		LFM200M480		94		
		LFM200M540		93		

ISOLATION CHARACTERISTICS

PARAMETER	NOTES and CONDITIONS	Device	Min.	Typ.	Max.	Units
Input to Output	1 Minute (without dielectric breakdown)	All			4250	V _{ac}
Input to Earth (Ground)	1 Minute (without dielectric breakdown)	All			2000	V _{ac}
Output to Earth (Ground)	1 Minute (without dielectric breakdown)	All			2000	V _{ac}
Isolation Resistance	Input to output	All	100			MΩ

FEATURE CHARACTERISTICS

PARAMETER	NOTES and CONDITIONS	Device	Min.	Typ.	Max.	Units
Switching Frequency		15V		130		kHz
		Others		110		



LFM200M Series

GENERAL SPECIFICATIONS

PARAMETER	NOTES and CONDITIONS	Device	Min.	Typ.	Max.	Units
MTBF	I _o =100%; T _a =25°C per MIL-HDBK-217F I _o =100%; T _a =25°C per Telcordia SR332	All	450 2800			k hours
Life Time (Detail refer to Application Note)	Conduction cooling @75% Load, 40°C Fan cooling @75% Load, 40°C	All		110 179		k hours
Humidity	Non-condensing	All			93	% RH
Shock	Meet MIL-STD-810F Table 516.5, Table 516.5-I 10ms, each axis 3 times(±X、±Y、±Z axis)	All		75		g
Vibration	Meet MIL-STD-810F Table 514.5C-VIII, 15~2000Hz, X、Y、Z axis, 1 hour (each axis), Total 3 hrs.	All		4		g
Weight	Baseplate versions Covered versions	LFM200MXXXB LFM200MXXXC		130 220		grams
Dimensions	Baseplate versions Covered versions	LFM200MXXXB LFM200MXXXC	3.04x2.00x1.00 Inches (77.2x50.8x25.4 mm) 3.09x2.28x1.00 Inches (78.6x57.9x25.4 mm)			
Safety	Class I, Class II ANSI/AAMI ES 60601-1, IEC 60601-1, EN 60601-1					Ed. 3.2
	Class I, IEC/EN/UL 62368-1					Ed. 3.0
EMC Emission	EN 55011 Class B, IEC/EN 61000-3-2, EN 61000-3-3, 47 CFR FCC Part 18 EN 55032, EN 61000-6-4, EN 61204-3, EN 61000-3-2, EN 61000-3-3, 47 CFR FCC Part 15					
Conducted Disturbance	EN 55011, EN 55032, 47 CFR FCC Part 18 & Part 15					Class B
Radiated Disturbance	EN 55011, 47 CFR FCC Part 18 (Class II Only Meets Class A), EN 55032, 47 CFR FCC Part 15					Class B
Harmonic Current Emissions	IEC/EN 61000-3-2					Class A, C, D
Voltage Fluctuations & Flicker	EN 61000-3-3					Criterion A
EMC Immunity	EN 60601-1-2, IEC/EN 61000-4-2, 3, 4, 5, 6, 8, 11					Ed 4.1
	EN 55035, EN 61000-6-2, EN 61204-3					
Electrostatic Discharge (ESD)	IEC 61000-4-2, Level 4: Air Discharge: ±15kV, Contact Discharge: ±8kV					Criterion A
Radio-Frequency, Continuous Radiated Disturbance	IEC/EN 61000-4-3, Level 3: 80~2700MHz, 10V/m					Criterion A
Electrical Fast Transient (EFT)	EN 61000-4-4, Level 3: ±2KV					Criterion A
Surge	EN 61000-4-5, Level 4: L-N: ±2kV, L-E (Ground): ±4kV					Criterion A
Conducted Disturbances, Induced by RF Fields	EN 61000-4-6, Level 3: 0.15~80MHz, 10V					Criterion A
Power Frequency Magnetic Field	EN 61000-4-8, Level 4: 30A/m					Criterion A
Voltage Dips	IEC/EN 61000-4-11, Dip: 30% Reduction IEC/EN 61000-4-11, Dip >95% Reduction					Criterion A
Voltage Interruptions	IEC/EN 61000-4-11, >95% Reduction					Criterion B
Application Note Link						LFM200M Series App Notes



LFM200M Series

CHARACTERISTIC CURVE

Power Derating Curve

Output Power vs Ambient Temperature

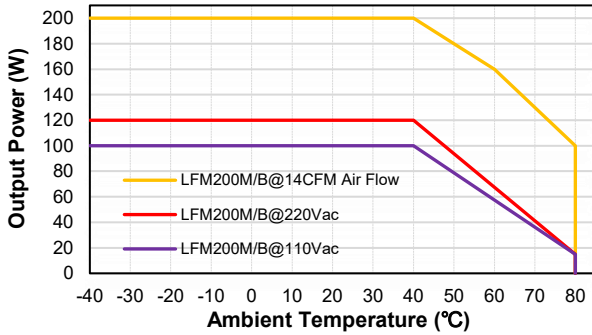

Output Power & Input Voltage

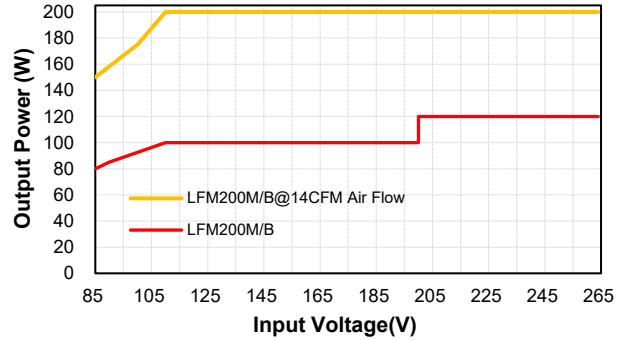

Output Power vs Ambient Temperature

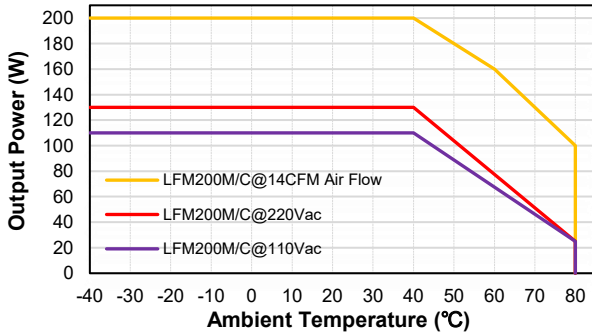

Output Power & Input Voltage

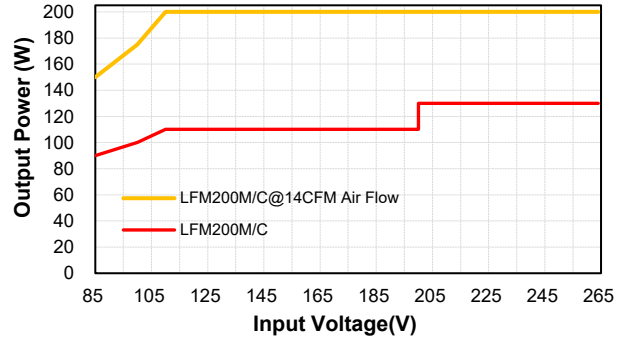

Conduction Convection with External Baseplate (17.78cmx17.78cmx0.2cm)

Output Power vs Ambient Temperature

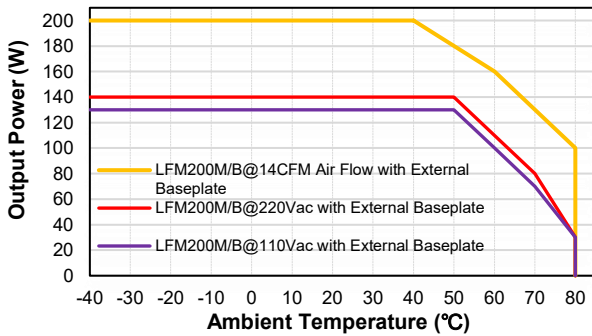

Output Power & Input Voltage

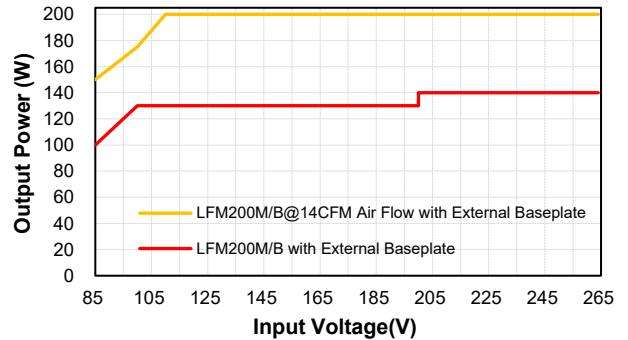



LFM200M Series

Output Power vs Ambient Temperature

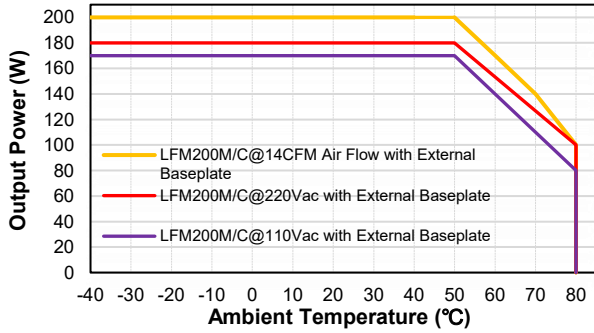

Output Power & Input Voltage

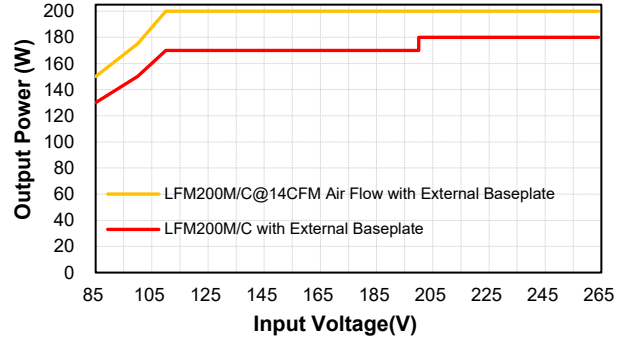

Output Power vs Case Temperature (T_c)

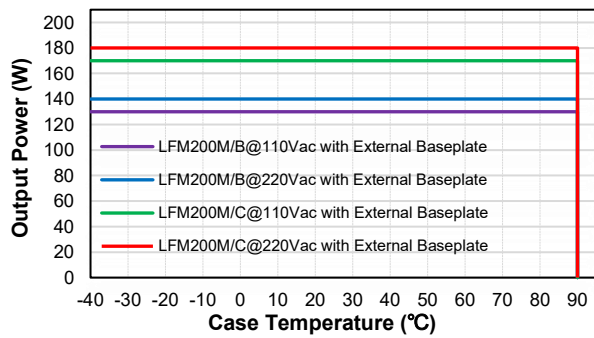

Performance Data

LFM200M120 (Eff Vs I_o)

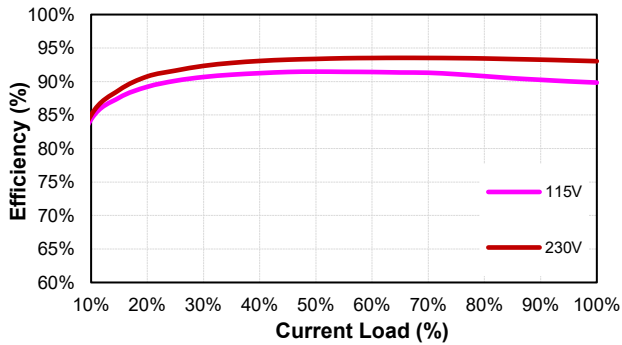

LFM200M150 (Eff Vs I_o)

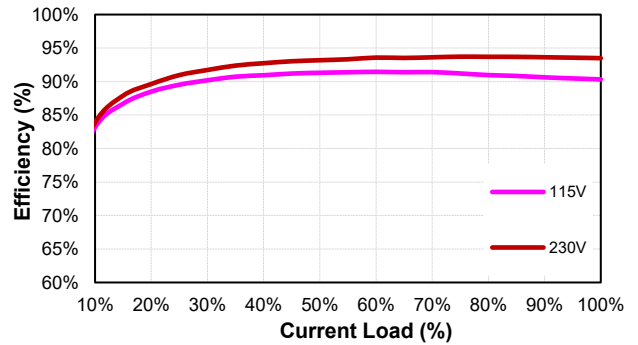

LFM200M240 (Eff Vs I_o)

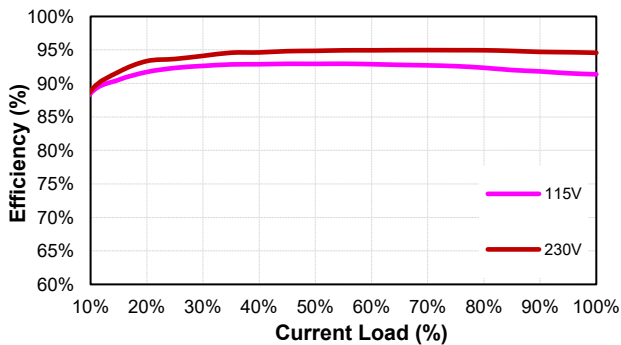

LFM200M280 (Eff Vs I_o)

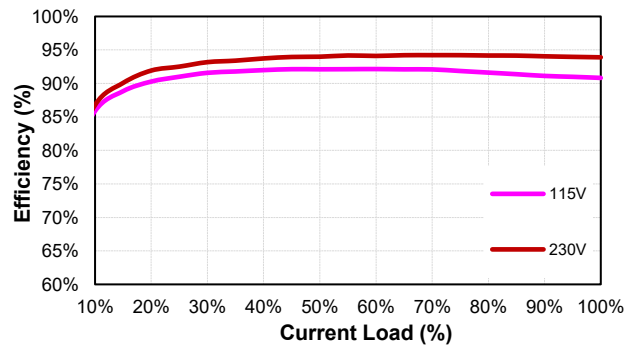



LFM200M Series

LFM200M300 (Eff Vs Io)

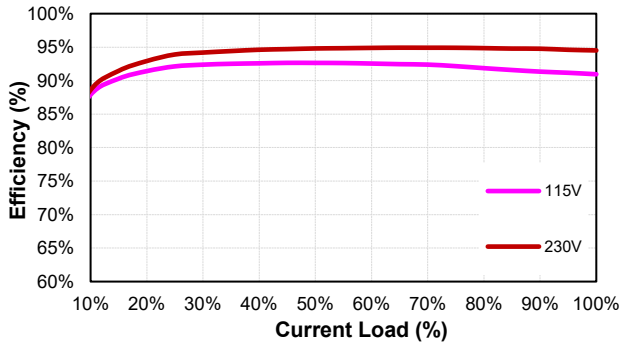

LFM200M360 (Eff Vs Io)

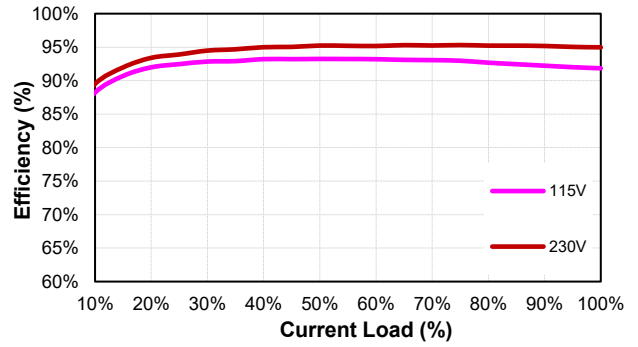

LFM200M480 (Eff Vs Io)

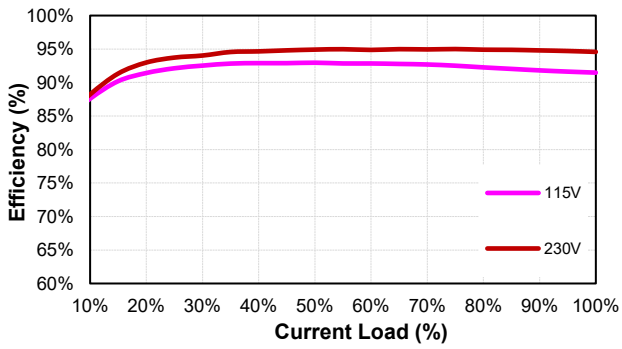

LFM200M540 (Eff Vs Io)

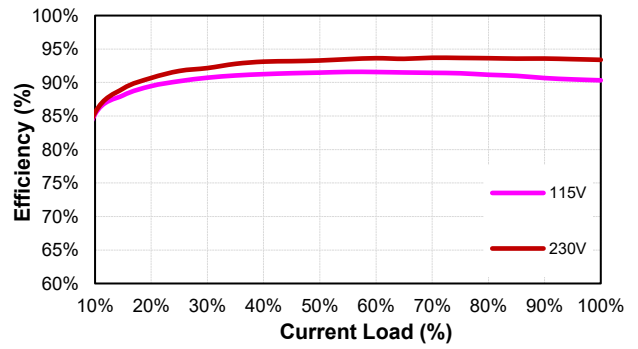



LFM200M Series

MECHANICAL SPECIFICATION

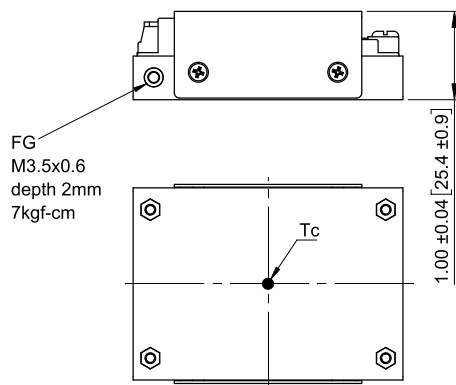
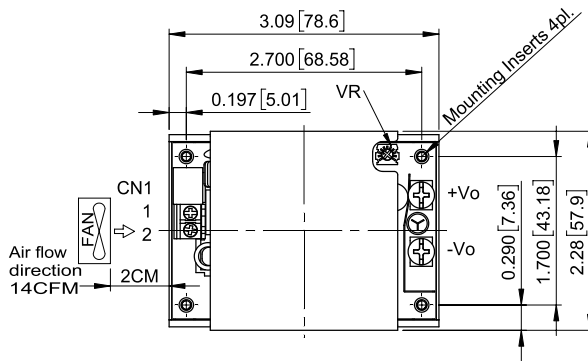

LFM200MXXXC LFM200MXXXC-C0

All Dimensions in Inches[mm]
Tolerance Inches: x.xx=±0.03, x.xxx=±0.020
Millimeters: x.x=±0.7, x.xx=±0.50

AC Input Connector(CN1):ECE ETB22

Pin	Function	Mating Wire Range
1	ACL	14~18 AWG
2	ACN	

DC Output Connector:KANG YANG PCB-58M4

Function	The screw locked torque
+Vo	M4 7kgf-cm
-Vo	

Mounting Inserts

Series	Option
Blank	∅3.2 Through depth 10.5mm
-C0	M3x0.5 Threaded depth 10.5mm

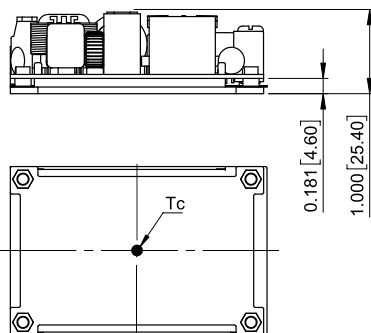
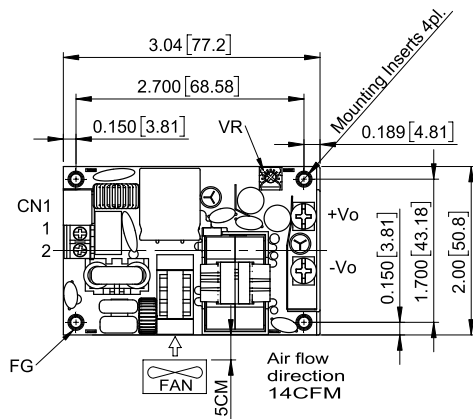

LFM200MXXXB LFM200MXXXB-C0

All Dimensions in Inches[mm]
Tolerance Inches: x.xx=±0.03, x.xxx=±0.020
Millimeters: x.x=±0.7, x.xx=±0.50

AC Input Connector(CN1):ECE ETB22

Pin	Function	Mating Wire Range
1	ACL	14~18 AWG
2	ACN	

DC Output Connector:KANG YANG PCB-58M4

Function	The screw locked torque
+Vo	M4 7kgf-cm
-Vo	

Mounting Inserts

Series	Option
Blank	∅3.2 Through depth 8.1mm
-C0	M3x0.5 Threaded depth 8.1mm

CINCON Electronics Co. Ltd.
Add: 14F, No. 306, Sec.4, Hsin Yi Rd., Taipei, Taiwan
Tel: 886-2-27086210
Fax: 886-2-27029852
E-mail: sales@cincon.com
Web: www.cincon.com

Authorised, valued-added distributor

Australia & New Zealand



Powerbox Australia Pty Ltd

Sydney Head Office
4 Beaumont Road,
Mt Kuring-Gai, NSW 2080
Australia



1800 251 380



sales@powerbox.com.au



powerbox.com.au

Powerbox Pacific Ltd

New Zealand Sales Office
1a Henry Rose Place,
Albany, Auckland
New Zealand 0632



09 4158 320



sales@powerbox.co.nz



powerbox.co.nz