

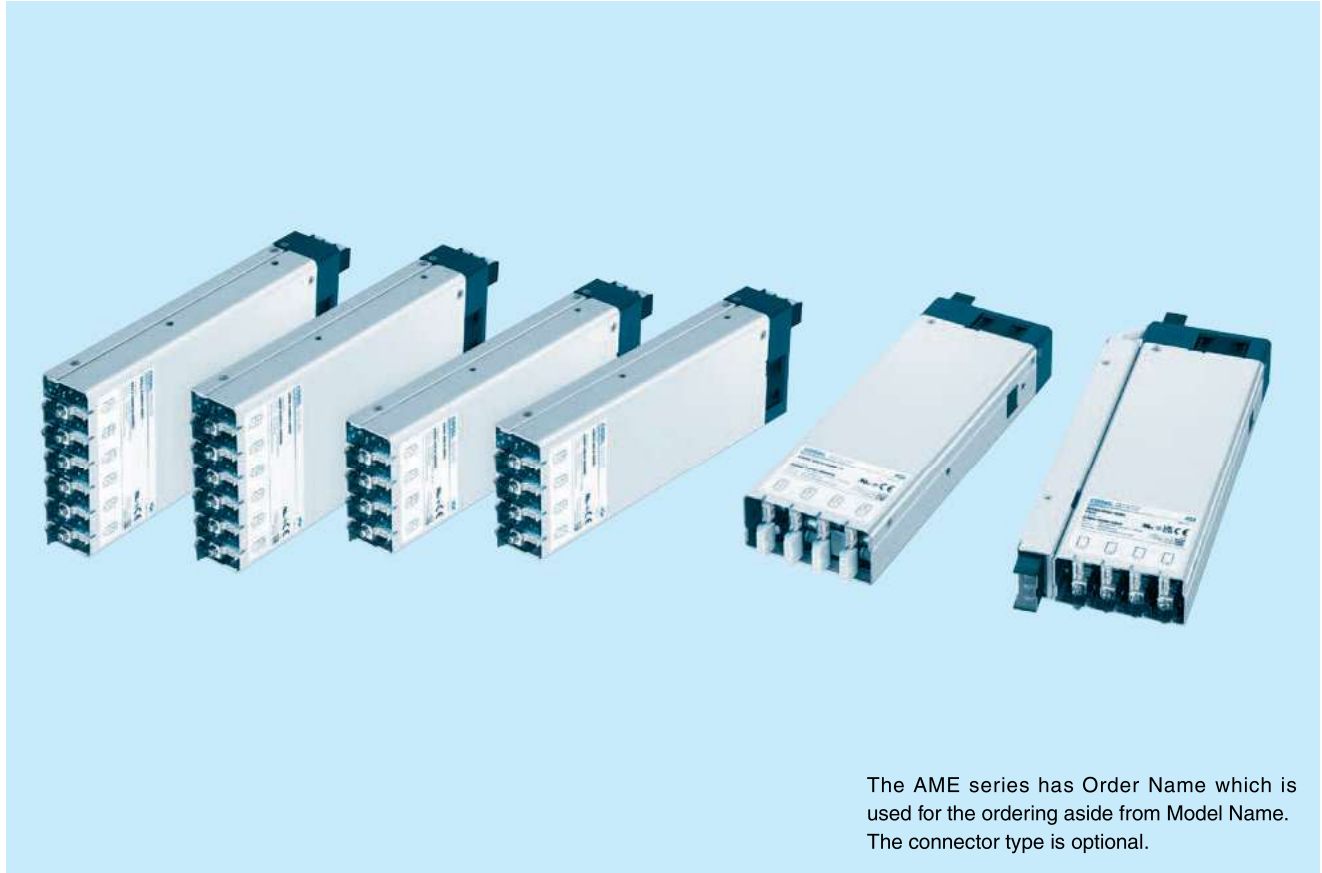

AME-series



The AME series has Order Name which is used for the ordering aside from Model Name. The connector type is optional.

Feature

- Flexible modular system architecture provides various output configuration
- Low profile (41mm, 1.61inch=meet to 1U height)
- Universal input (AC85-264V)
- For medical electric equipment (ANSI/AAMI ES60601-1, EN60601-1 3rd, IEC60601-1-2 4th Ed.)
- With AUX output 5V 1A
- Global inhibit, Remote ON/OFF control
- Connector type output terminal (Option)
- Monitoring function and some parameter changes by communication are available (Option)

Safety agency approvals

- UL62368-1, ANSI/AAMI ES60601-1
- C-UL (CAN/CSA62368-1), C-UL (CAN/CSA60601-1)
- EN62368-1, EN60601-1 3rd

5-year warranty (refer to Instruction Manual)

CE marking

- Low Voltage Directive
- RoHS Directive

UKCA marking

- Electrical Equipment Safety Regulations
- RoHS Regulations

EMI

- Complies with FCC-B, CISPR11-B, CISPR32-B, EN55011-B, EN55032-B, VCCI-B

EMS Compliance : EN61204-3, EN61000-6-2

IEC60601-1-2 (2014), EN60601-1-2 (2015)

- EN61000-4-2
- EN61000-4-3
- EN61000-4-4
- EN61000-4-5
- EN61000-4-6
- EN61000-4-8
- EN61000-4-11

AME series

AM - -

① ② ③ ④ ⑤ ⑥ ⑦ ⑧ ⑨ ⑩ ⑪

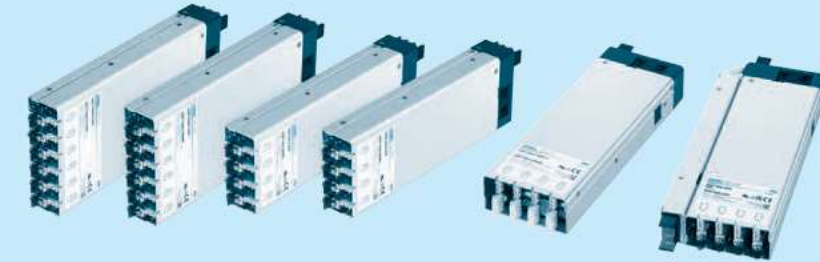

Output connector type (option: -J2)

Input Direction Changed type (option: -T)

2MOPP



Example recommended EMI/EMC filter
 AME400F NAC-06-472
 AME600F NAC-10-472
 AME800F NAC-16-472
 AME1200F NAC-20-472



High voltage pulse noise type : NAP series
 Low leakage current type : NAM series
 * A higher current rating EMI/EMC filter may be recommended in view of the other devices that could be connected in parallel with the power supply.

- ① Abbreviation for series name of AME series
- ② Abbreviation for output power of AME series
04 : AME400F
06 : AME600F
08 : AME800F
12 : AME1200F
- ③ Slot 6 Output module
- ④ Slot 5 Output module
- ⑤ Slot 4 Output module
- ⑥ Slot 3 Output module
- ⑦ Slot 2 Output module
- ⑧ Slot 1 Output module
- ⑨ Parallel code
- ⑩ Series code
- ⑪ Option #6
A : 12V/0.1A AUX instead of 5V1A
C : with Coating
F3 : Reverse air exhaust type
G : Low leakage current
I : with PMBus interface
I3 : with Extended-UART interface
J2 : Output connector type
J3 : CN1/CN2/CN3 Molex connectors
R : Reversed logic remote on/off
T : Input Direction Changed type
Refer to instruction manual 6.1

The AME series has Order Name which is used for the ordering aside from Model Name.

* Make sure necessary tests will be carried out on your end equipment with the power supply installed in accordance with any required EMC/EMI regulations.

SPECIFICATIONS

MODEL	AME400F	AME600F	AME800F	AME1200F
INPUT				
VOLTAGE [VAC]	*2 85-264 1 φ			
CURRENT [A]	ACIN 100V *7 3.0typ	5.0typ	7.0typ	12typ
	ACIN 230V *7 2.0typ	3.2typ	4.0typ	6.4typ
FREQUENCY [Hz]	50/60 (45 - 66)			
EFFICIENCY [%]	ACIN 100V *7 85typ	87typ	87typ	88typ
	ACIN 230V *7 89typ	91typ	90typ	91typ
POWER FACTOR	ACIN 100V *7 0.98typ	0.98typ	0.98typ	0.98typ
	ACIN 230V *7 0.95typ	0.95typ	0.95typ	0.95typ
INRUSH CURRENT [A]	ACIN 100V *1 15/50typ (Po = 100%)(Primary inrush current / Secondary inrush current) (More than 3 sec. to re-start)			
	ACIN 230V *1 35/50typ (Po = 100%)(Primary inrush current / Secondary inrush current) (More than 3 sec. to re-start)			
LEAKAGE CURRENT [mA]	0.30max (ACIN 240V 60Hz, Io = 100%, According to IEC60601-1)			
OUTPUT				
NUMBER OF SLOT	4		6	
TOTAL OUTPUT [W]	ACIN 90-150V *2 250	400	600	1000
	ACIN 170-264V *2 400	600	800	1200
START-UP TIME [ms]	800typ (ACIN 100V, Po = 100%)			
HOLD-UP TIME [ms]	*7 20typ (ACIN230V, Po = 80%) / 16typ (ACIN230V, Po = 100%)			
FUNCTION				
AUXILIARY POWER (AUX)	5V1A			
GLOBAL INHIBIT (GI)	Provided			
ALARM (PR)	Provided			
ISOLATION				
INPUT - OUTPUT	4,000VAC 1minute, Cutoff current = 10mA, 500VDC 50MΩ min (At Room Temperature) 2MOPP			
INPUT - FG	2,000VAC 1minute, Cutoff current = 10mA, 500VDC 50MΩ min (At Room Temperature) 1MOPP			
OUTPUT - FG (Except output module V, V4, V5)	500VAC 1minute, Cutoff current = 100mA, 500VDC 50MΩ min (At Room Temperature)			
OUTPUT - FG (Output module V, V4, V5)	1,000VAC 1minute, Cutoff current = 100mA, 500VDC 50MΩ min (At Room temperature) 1MOOP			
OUTPUT - RC, LV, AUX, PR, GI	*3 500VAC 1minute, Cutoff current = 100mA, 500VDC 50MΩ min (At Room Temperature)			
ENVIRONMENT				
OPERATING TEMP., HUMIDITY. AND ALTITUDE	*2 -20 to +70°C, 20 - 90%RH (Non condensing)			
STORAGE TEMP., HUMIDITY. AND ALTITUDE	-20 to +75°C, 20 - 90%RH (Non condensing)			
VIBRATION	10 - 55Hz 19.6m/s ² (2G) 3minutes period, 60minutes each along X, Y and Z axis			
IMPUCT	196.1m/s ² (20G) 11ms, once each X, Y and Z axis			
SAFETY AND NOISE REGULATIONS				
AGENCY APPROVALS	UL62368-1, C-UL (CAN/CSA-C22.2 No.62368-1), EN62368-1, ANSI/AAMI ES60601-1, C-UL (CAN/CSA-C22.2 No.60601-1), EN60601-1 3rd Complies with IEC60601-1-2 4th Ed.			
CONDUCTED NOISE	Complies with FCC-B, VCCI-B, CISPR11-B, CISPR32-B, EN55011-B, EN55032-B			
HARMONIC ATTENUATOR	*5 Complies with IEC61000-3-2 (classA)			
OTHERS				
CASE SIZE	*4 89 X 41 X 257mm (W X H X D) [3.50 X 1.61 X 10.12 inches]		127 X 41 X 257mm (W X H X D) [5.00 X 1.61 X 10.12 inches]	
WEIGHT [kg]	1.2max		1.8max	
COOLING METHOD	Forced cooling (internal fan)			

*1 The current of input surge to a built-in EMI/EMS Filter(0.2ms or less) is excluded.
 *2 Refer to "Derating".
 *3 Each output module,V1-V2 (only module P, Q, R), RC, LV, AUX (include GI1), PR and GI (GI2,GIG) are isolated.
 *4 Case size contains neither the terminal blocks, screw nor other projections.
 *5 Please contact us about other classes.
 *6 Please contact us about safety approvals for the model with option.
 *7 At the total output power.
 The value depends on the combination of output modules or load factor.
 * The audible noise might be emitted from the power supply at the pulse load.

Output module specifications

ITEM	CODE	120W suitable single output								240W suitable single output		
		J	A	K	B	L	C	M	D	E4	E	S
Number of slots used		1	1	1	1	1	1	1	1	1	1	1
VOLTAGE [V]		3.3	5	7.5	12	15	24	36	48	3.3	5	7.5
MINIMUM CURRENT [A]		0	0	0	0	0	0	0	0	0	0	0
CURRENT [A]		15.2	12	12	8.5	8	5	3.4	2.5	32	32	24
PEAK CURRENT [A]	*3	-	-	-	-	-	-	-	-	-	-	-
LINE REGULATION [mV] max		20	20	36	48	60	96	120	192	20	20	36
LOAD REGULATION [mV] max		40	40	100	100	120	150	180	240	40	40	100
RIPPLE [mVp-p] max	0 to +50°C *1	150	150	150	150	150	250	250	400	150	150	150
	-20 to 0°C *1	200	200	200	200	200	300	300	450	200	200	200
RIPPLE NOISE [mVp-p] max	0 to +50°C *1	200	200	200	200	200	300	300	450	200	200	200
	-20 to 0°C *1	250	250	250	250	250	350	350	500	250	250	250
TEMPERATURE COEFFICIENT [mV] max	0 to +50°C	50	50	90	120	150	240	300	480	50	50	90
DRIFT [mV] max	*2	20	20	36	48	60	96	120	192	20	20	36
OUTPUT VOLTAGE SETTING [V]		3.30 to 3.40	5.00 to 5.15	7.50 to 7.80	12.00 to 12.48	15.00 to 15.60	24.00 to 24.96	36.00 to 37.44	48.00 to 49.92	3.30 to 3.40	5.00 to 5.15	7.50 to 7.80
OUTPUT VOLTAGE ADJUSTMENT RANGE [V]		2.64 to 3.96	4.0 to 6.0	6.0 to 9.0	9.6 to 14.4	12.0 to 18.0	19.2 to 28.8	28.8 to 43.2	38.4 to 57.6	3.0 to 6.0	3.0 to 6.0	4.5 to 9.0
OVERCURRENT PROTECTION [A]		Works over 105% min of rated current. Automatic recovery. Hiccup mode.								Works over 105% min of rated current. Automatic recovery. Hiccup mode.		
OVERVOLTAGE PROTECTION [V]		4.2 to 5.6	6.5 to 7.8	9.4 to 11.6	15.0 to 18.6	18.8 to 23.2	30.0 to 37.2	45.0 to 55.8	60.0 to 74.4	Vo+1.0 to 1.5 Vo+1.0 to 1.5 Vo+1.0 to 1.7		
FUNCTION		Remote ON/OFF (RC), Alarm (LV), DC_OK (LED: Blue)								Remote ON/OFF (RC), Alarm (LV), Remote sensing (+S/-S), Output voltage adjustment (VTRM), Constant output current adjustment (ITRM), DC_OK (LED: Blue)		

ITEM	CODE	240W suitable single output										
		F4	F	T	G4	G	U	H4	H	V4	V	V5
Number of slots used		1	1	1	1	1	1	1	1	1	1	1
VOLTAGE [V]		7.5	12	15	15	24	36	36	48	65	75	100
MINIMUM CURRENT [A]		0	0	0	0	0	0	0	0	0	0	0
CURRENT [A]		20	20	16	10	10	6.7	5	5	3	3	2.25
PEAK CURRENT [A]	*3	-	-	-	15	15	10	7.5	7.5	-	-	-
LINE REGULATION [mV] max		48	48	60	96	96	120	192	192	300	300	300
LOAD REGULATION [mV] max		100	100	120	150	150	180	240	240	350	350	350
RIPPLE [mVp-p] max	0 to +50°C *1	150	150	150	250	250	250	400	400	500	500	500
	-20 to 0°C *1	200	200	200	300	300	300	450	450	550	550	550
RIPPLE NOISE [mVp-p] max	0 to +50°C *1	200	200	200	300	300	300	450	450	550	550	550
	-20 to 0°C *1	250	250	250	350	350	350	500	500	600	600	600
TEMPERATURE COEFFICIENT [mV] max	0 to +50°C	120	120	150	240	240	300	480	480	750	750	750
DRIFT [mV] max	*2	48	48	60	96	96	120	192	192	300	300	300
OUTPUT VOLTAGE SETTING [V]		7.50 to 7.80	12.00 to 12.48	15.00 to 15.60	15.00 to 15.60	24.00 to 24.96	36.00 to 37.44	36.00 to 37.44	48.00 to 49.92	65.00 to 67.60	75.00 to 78.00	100.0 to 104.0
OUTPUT VOLTAGE ADJUSTMENT RANGE [V]		7.2 to 14.4	7.2 to 14.4	9.0 to 18.0	14.4 to 28.8	14.4 to 28.8	21.6 to 43.2	28.8 to 57.6	28.8 to 57.6	57.6 to 105.0	57.6 to 105.0	57.6 to 105.0
OVERCURRENT PROTECTION [A]		Works over 105%min of rated current or 101%min of peak current. Automatic recovery. Hiccup mode.										
OVERVOLTAGE PROTECTION [V]		Vo+1.2 to 2.4	Vo+1.2 to 2.4	Vo+1.5 to 3.0	Vo+2.4 to 4.8	Vo+2.4 to 4.8	Vo+3.6 to 7.2	Vo+4.8 to 7.2	Vo+4.8 to 7.2	Vo+7.5 to 11.3	Vo+7.5 to 11.3	Vo+7.5 to 11.3
FUNCTION		Remote ON/OFF (RC), Alarm (LV), Remote sensing (+S/-S), Output voltage adjustment (VTRM), Constant output current adjustment (ITRM), DC_OK (LED: Blue)										

ITEM	CODE	300W suitable single output			150W isolated dual output						
		2C	2M	2D	P*4		Q*4		R		
Number of slots used		2	2	2	1		1		1		
VOLTAGE [V]		24	36	48	V1:12	V2:12	V1:15	V2:15	V1:24	V2:24	
MINIMUM CURRENT [A]		0	0	0	0	0	0	0	0	0	
CURRENT [A]		14	9.3	7	8	8	7	7	3	3	
PEAK CURRENT [A]	*3	15	10	7.5	10	10	8	8	-	-	
LINE REGULATION [mV] max		96	120	192	48	48	60	60	96	96	
LOAD REGULATION [mV] max		150	180	240	100	100	120	120	150	150	
RIPPLE [mVp-p] max	0 to +50°C *1	250	250	400	140	140	140	140	250	250	
	-20 to 0°C *1	300	300	450	200	200	200	200	300	300	
RIPPLE NOISE [mVp-p] max	0 to +50°C *1	300	300	450	230	230	230	230	300	300	
	-20 to 0°C *1	350	350	500	350	350	350	350	350	350	
TEMPERATURE COEFFICIENT [mV] max	0 to +50°C	240	300	480	120	120	150	150	350	350	
DRIFT [mV] max	*2	96	120	192	48	48	60	60	96	96	
OUTPUT VOLTAGE SETTING [V]		24.00 to 24.96	36.00 to 37.44	48.00 to 49.92	12.00 to 12.48	12.00 to 12.48	15.00 to 15.60	15.00 to 15.60	23.88 to 24.96	23.88 to 24.96	
OUTPUT VOLTAGE ADJUSTMENT RANGE [V]		14.4 to 28.8	21.6 to 43.2	28.8 to 57.6	5.0 to 13.2	5.0 to 13.2	5.0 to 16.5	5.0 to 16.5	5.0 to 25.2	5.0 to 25.2	
OVERCURRENT PROTECTION [A]		Works over 105% min of rated current or 101%min of peak current. Automatic recovery. Hiccup mode.								Works over 105% min of rated current. Automatic recovery.	
OVERVOLTAGE PROTECTION [V]		Vo+2.4 to 4.8	Vo+3.6 to 7.2	Vo+4.8 to 7.2	15.0 to 18.6	15.0 to 18.6	18.8 to 23.2	18.8 to 23.2	30.0 to 37.2	30.0 to 37.2	
FUNCTION		Remote ON/OFF (RC), Alarm (LV), Remote sensing (+S/-S), Output voltage adjustment (VTRM), Constant output current adjustment (ITRM), DC_OK (LED: Blue)			Remote ON/OFF (RC) Alarm (LV) DC_OK (LED: Blue)						

*1 Measured by 20MHz oscilloscope or Ripple-Noise meter (equivalent to KEISOKUGIKEN: RM104).

*2 Drift is the change in DC output for an eight hours period after a half-hour warm-up at 25°C.

*3 The peak current should be under the following conditions.

- Duration: 5s or less
- Duty: 35% or less
- Average current: Rated current or less

*4 The total output power of V1 and V2 must be less than output power (P: 153.6W, Q: 165W).

AME400F/AME600F external view

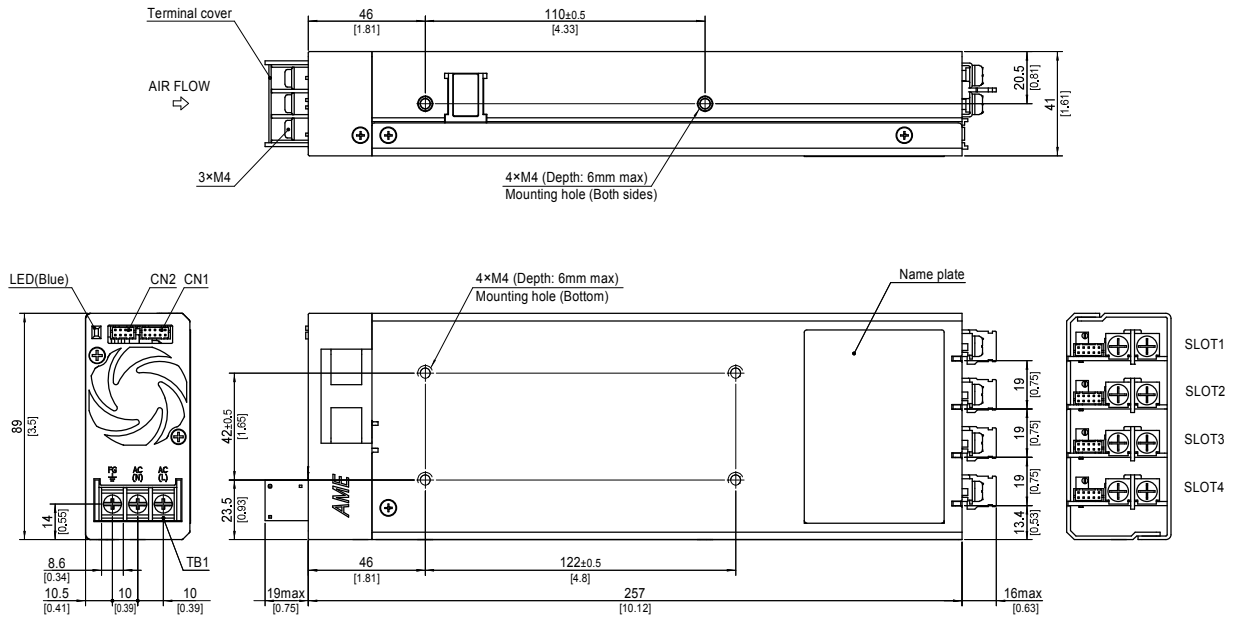

- ※ Tolerance : ±1 [±0.04]
- ※ Weight : 1.2kg max
- ※ PCB Material/thickness : FR-4 / 1.6mm [0.06]
- ※ Chassis material : Aluminum
- ※ Fan cover Material : PBT
- ※ Dimensions in mm, [] = inches
- ※ Mounting torque M4 : 1.2N·m max
- ※ Input and output terminal screw tightening torque M4 : 1.6N·m max
- ※ Please connect safety ground to Mounting Hole or FG terminal on the unit.

AME800F/AME1200F external view

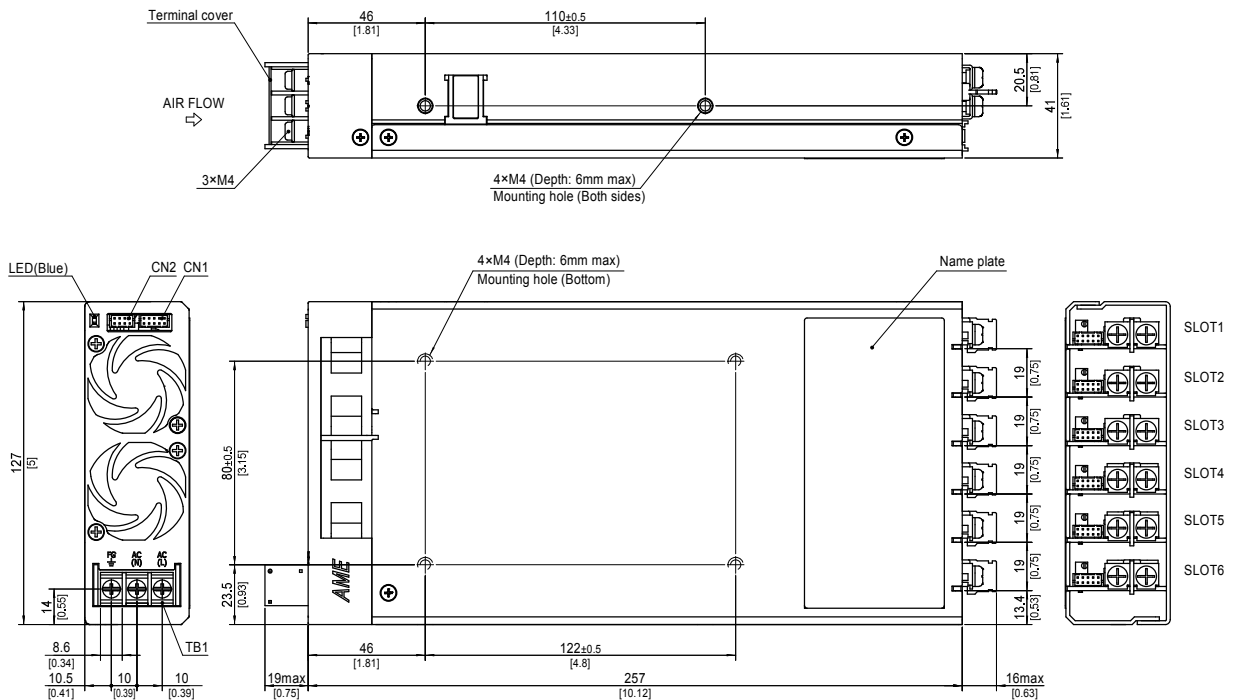

- ※ Tolerance : ±1 [±0.04]
- ※ Weight : 1.8kg max
- ※ PCB Material/thickness : FR-4 / 1.6mm [0.06]
- ※ Chassis material : Aluminum
- ※ Fan cover Material : PBT
- ※ Dimensions in mm, [] = inches
- ※ Mounting torque M4 : 1.2N·m max
- ※ Input and output terminal screw tightening torque M4 : 1.6N·m max
- ※ Please connect safety ground to Mounting Hole or FG terminal on the unit.

AME400F/AME600F external view (option:-T)

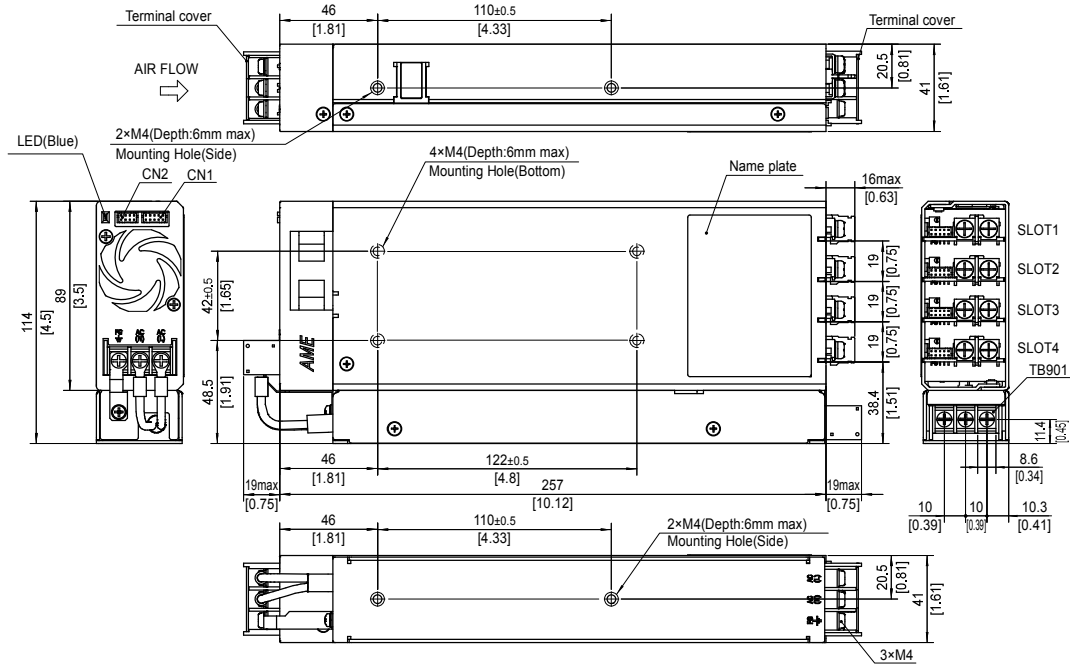

※ Tolerance : ±1 [±0.04]

※ Weight : 1.4kg max

※ PCB Material/thickness : FR-4 / 1.6mm [0.06]

※ Chassis material : Aluminum

※ Fan cover Material : PBT

※ Dimensions in mm, [] = inches

※ Mounting torque M4 : 1.2N · m max

※ Input and output terminal screw tightening torque M4 : 1.6N · m max

※ Please connect safety ground to Mounting Hole or FG terminal of TB901.

AME800F/AME1200F external view (option:-T)

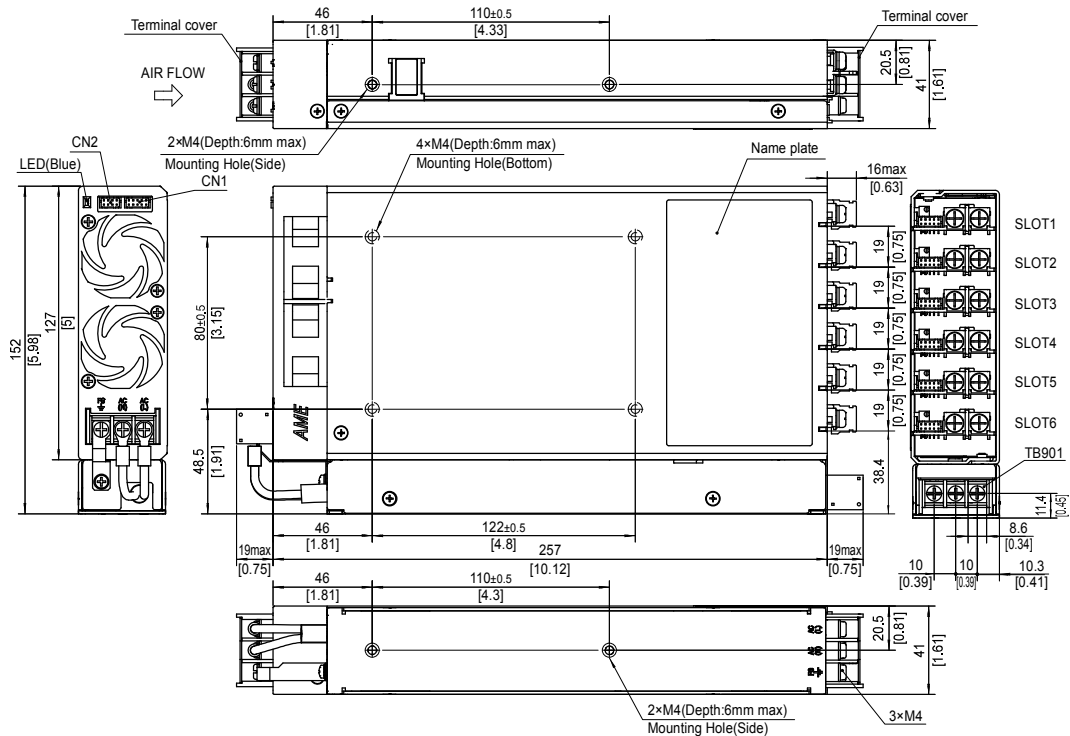

※ Tolerance : ±1 [±0.04]

※ Weight : 2.0kg max

※ PCB Material/thickness : FR-4 / 1.6mm [0.06]

※ Chassis material : Aluminum

※ Fan cover Material : PBT

※ Dimensions in mm, [] = inches

※ Mounting torque M4 : 1.2N · m max

※ Input and output terminal screw tightening torque M4 : 1.6N · m max

※ Please connect safety ground to Mounting Hole or FG terminal of TB901.

Output module

1. Output side view

AME400F/AME600F Output side view

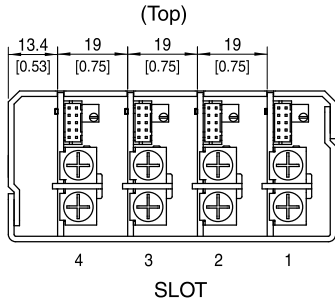

AME800F/AME1200F Output side view

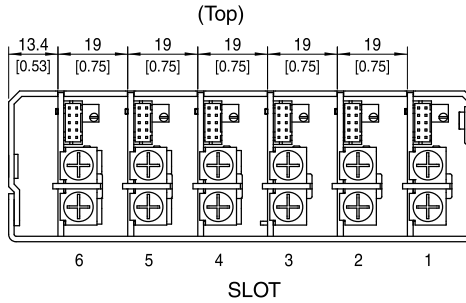

※Tolerance : ±1 [±0.04]
 ※Dimensions in mm, []=inches

2. Output module side view

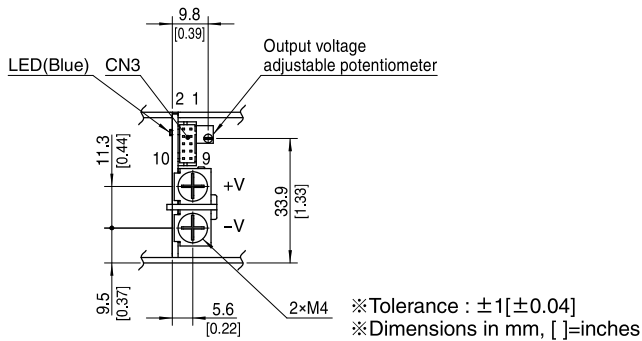

Module : A-H,J-M,S-V,E4-H4,V4,V5,2C-2M

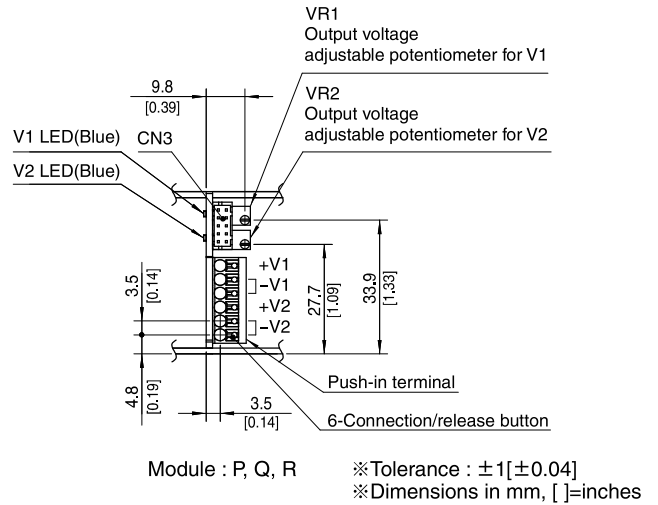

Terminal Blocks and connector pin assign

● AME400F/AME600F

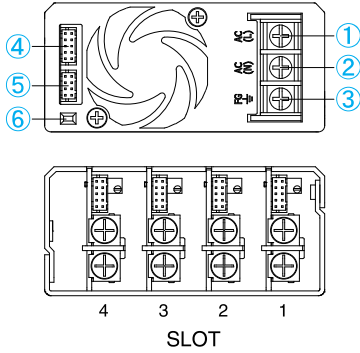

● AME800F/AME1200F

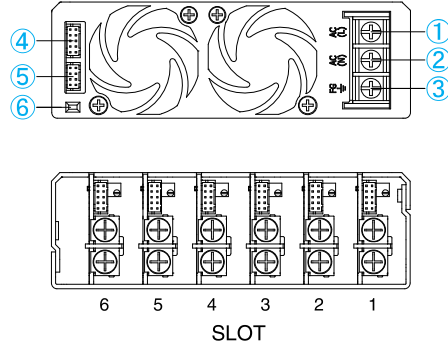

● AME400F/AME600F (option : -T)

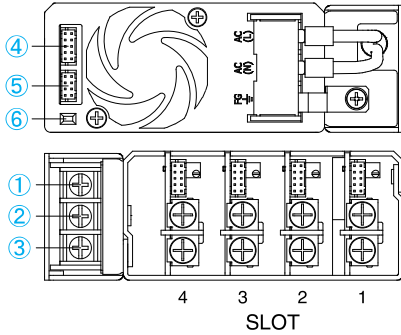

● AME800F/AME1200F (option : -T)

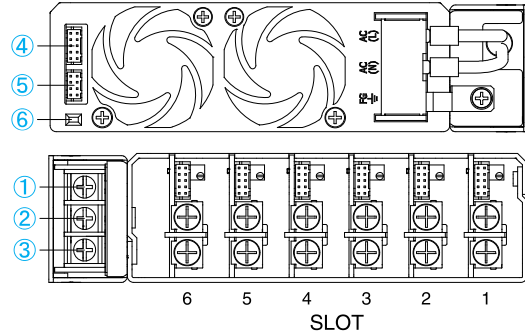

- ① AC (L) } Input Terminals 85 - 264VAC 1 φ 45 - 66Hz
- ② AC (N) } (M4)
- ③ Frame ground (M4)
- ④ CN1 } Connector for functions
- ⑤ CN2 }
- ⑥ LED (DC_OK)

● Pin Configuration and Functions

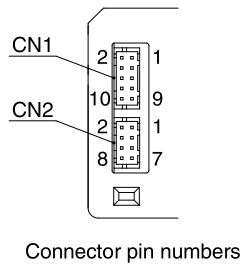

Matching connectors and terminals

Connector	Housing	Terminal	Mfr.
CN1	S10B-PHDSS	PHDR-10VS Reel : SPHD-002T-P0.5 Loose : BPHD-001T-P0.5 *1 BPHD-002T-P0.5 *1	J.S.T

* 1 The manufacturer can offer only ratchet hand tool.

Pin configuration and function of CN1

Pin No.	Function	Ground level
1	AUX : Auxiliary power	AUXG
2	AUXG : Auxiliary power ground	AUXG
3	GI1 : Global inhibit	AUXG
4	AUXG : Auxiliary power ground	AUXG
5	GI2 : Global inhibit	GIG
6	GIG : Global inhibit ground	GIG
7	N.C. : No connection	-
8	N.C. : No connection	-
9	PR : PR Alarm	PRG
10	PRG : PR Alarm ground	PRG

Pin configuration and function of CN2

Pin No.	Function	Ground level
1	N.C. : No connection	-
2	N.C. : No connection	-
3	N.C. : No connection	-
4	N.C. : No connection	-
5	N.C. : No connection	-
6	N.C. : No connection	-
7	N.C. : No connection	-
8	N.C. : No connection	-

* Do not connect anything to N.C. pins.

Terminal Blocks

● Output module

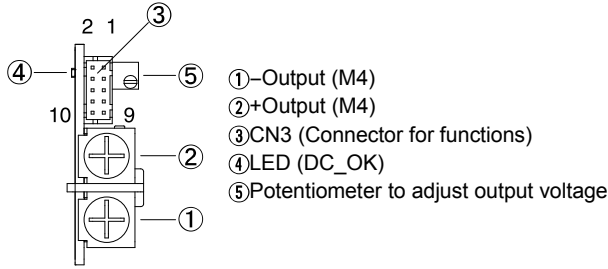

Module : A-H,J-M,S-V,E4-H4,V4,V5,2C-2M

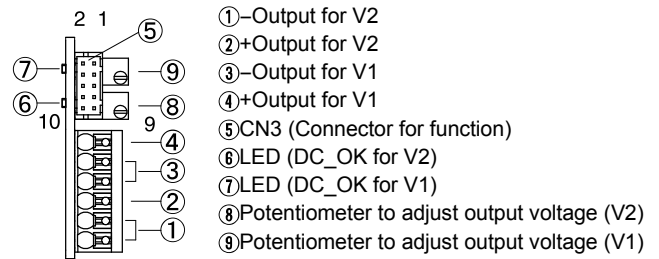

Module : P,Q,R

Pin configuration and function of CN3

Pin No.	Applying module : A-D,J-M		Applying Module : E4-H4,E-H,S-V,V4,V5,2C-2M		Applying Module : P,Q,R	
	Function	Ground level	Function	Ground level	Function	Ground level
1	RC : Remote ON/OFF	RCG	RC : Remote ON/OFF	RCG	V1_RC : Remote ON/OFF	V1_RCG
2	RCG : Remote ON/OFF ground	RCG	RCG : Remote ON/OFF ground	RCG	V1_RCG : Remote ON/OFF ground	V1_RCG
3	LV : LV Alarm	LVG	LV : LV Alarm	LVG	V1_LV : LV Alarm	V1_LVG
4	LVG : LV Alarm ground	LVG	LVG : LV Alarm ground	LVG	V1_LVG : LV Alarm ground	V1_LVG
5	N.C. : No connection	—	+S : + Remote sensing	COM	N.C. : No onnection	—
6	N.C. : No connection	—	-S : - Remote sensing	COM	N.C. : No onnection	—
7	N.C. : No connection	—	COM : Common ground for signal	COM	V2_RC : Remote ON/OFF	V2_RCG
8	N.C. : No connection	—	ITRM : Output current adjustment	COM	V2_RCG : Remote ON/OFF ground	V2_RCG
9	N.C. : No connection	—	VTRM : Enable VTRM	COM	V2_LV : LV Alarm	V2_LVG
10	N.C. : No connection	—	VTRM : Output voltage adjustment	COM	V2_LVG : LV Alarm ground	V2_LVG

* Do not connect anything to N.C. pins.

Matching connectors and terminals

Connector	Housing	Terminal	Mfr.
CN3	S10B-PHDSS	PHDR-10VS Reel : SPHD-002T-P0.5 Loose : BPHD-001T-P0.5 *1 BPHD-002T-P0.5 *1	J.S.T

*1 The manufacturer prepares only the ratchet hand.

Assembling and Installation Method

- The unit has cooling fans.
Ensure that the inlet and outlet vents are not blocked.
- If the unit is used in dusty environment, please consider installing the air filter so that cooling efficiency will not get worse. In that case, please pay sufficient attention to airflow.
- Figures to the right are the recommended installation method when the unit is mounted by screws. When the unit is installed by any other method, please take into account of its weight and secure it.
- Avoid the D installation method in the figure to the right because it will cause stress on the mounting holes.
- Maximum length from the outside of the unit of the mounting screws is 6mm so that the isolation to internal components is ensured. (Refer to right figure).
- Applicable Wire for module P, Q, and R

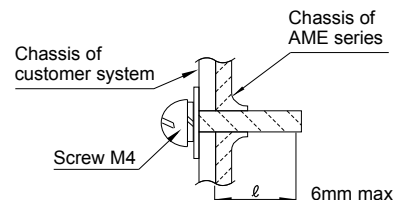
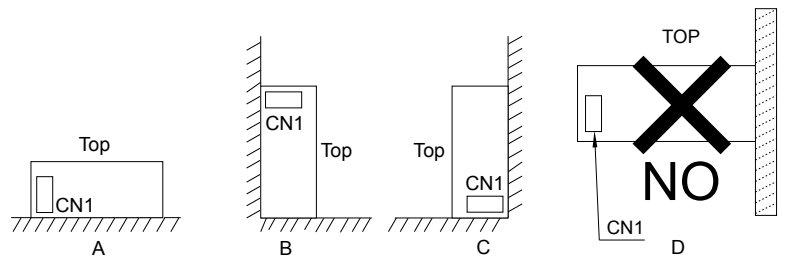

Applicable Wire	
Solid wire	Diameter 0.5mm to 1.3mm (AWG.24 to AWG.16)
Standed wire	0.2mm ² to 1.5mm ² (AWG.24 to AWG.16)
Sheath strip length	8mm to 9mm

Derating

■The AME series is comprised multiple combination output. Both the maximum output of each module and total maximum output have to be within the specs.

Derating curve for input voltage

● AME400F

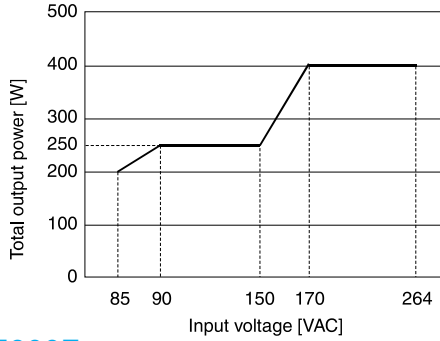

● AME600F

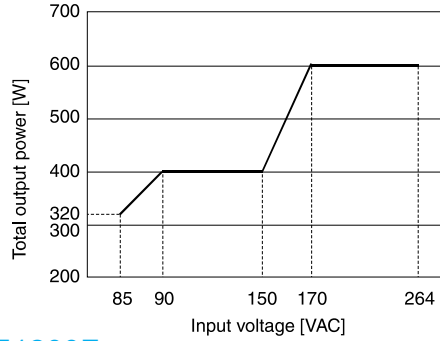

● AME800F

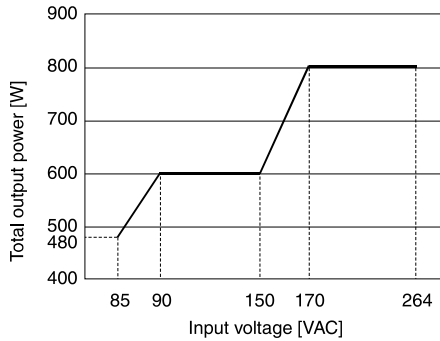

● AME1200F

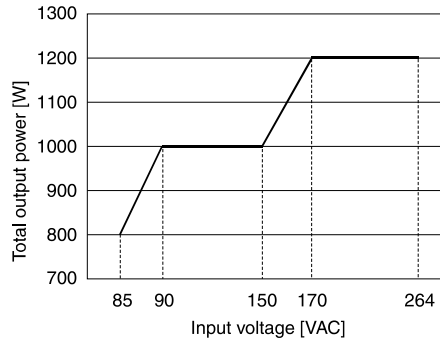

Derating curve for ambient temperature

■Derating curve for ambient temperature

The derating curve for the ambient temperature (inlet temperature for cooling) is shown in below. The specifications of the ripple and noise in the hatching area below are different.

● AME400F

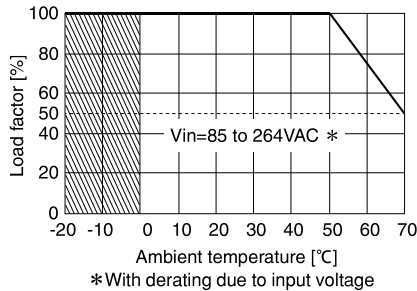

● AME600F

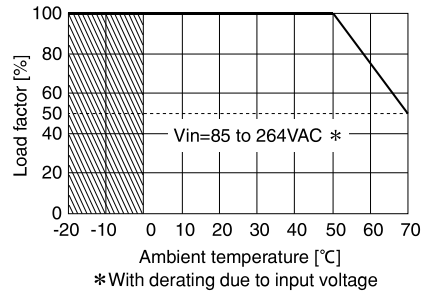

● AME800F

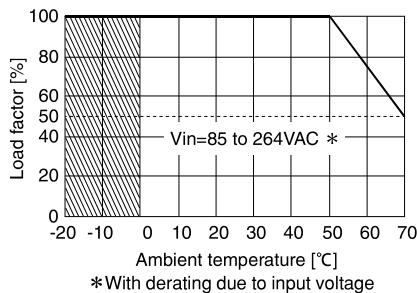

● AME1200F

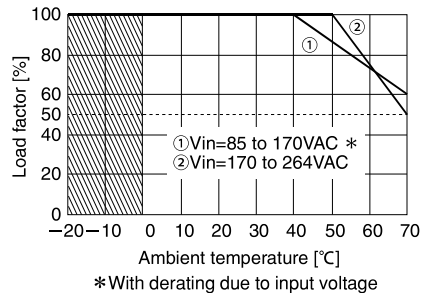

Definition of load factor

■ Definition of load factor

Load [%] = The largest value of $A_0, A_{11} - A_{62}$

$$A_0 = \frac{(\text{Sum of each module power})}{(\text{Total output power})} \times 100 = \frac{\sum_{k=1}^6 (I_{k1} \times V_{k1} + I_{k2} \times V_{k2})}{(\text{Total output power})} \times 100$$

$$A_{11}, A_{21}, A_{31}, A_{41}, A_{51}, A_{61} : AK_1 = I_{k1} / I_{OK1} \times 100$$

$$A_{12}, A_{22}, A_{32}, A_{42}, A_{52}, A_{62} : AK_2 = I_{k2} / I_{OK2} \times 100$$

I_{k1}, V_{k1}, I_{OK1} : output current, voltage, and rated current except for V2 in module P, Q, and R

I_{k2}, V_{k2}, I_{OK2} : output current, voltage, and rated current for V2 in module P, Q, and R

Total output power : Dependent upon input voltage

Suffix k means the k-th slot

※If you use the module that apply peak current at the peak current, " I_{k1} " is calculated by peak current.

When Calculating load factor of module, " I_{k1} " is calculated by average current.

A method of use peak current, Refer to 4 Peak in Instruction Manual

■ Usage example

[Example1] Method to confirm that AM04-RDBA-0000 can be used under the following conditions.

Input voltage : 100VAC Ambient temperature : 50°C

Output model : slot1 : 5V 12A slot2 : 5V 12A slot3 : 48V 1A slot4 : 24V 2A, 24V 1A

According to the "Derating curve for input voltage", total output power is 250W.

Calculating $A_{11} - A_{42}$

$$A_0 = (5 \times 12 + 12 \times 5 + 48 \times 1 + 24 \times 2 + 24 \times 1) / 250 \times 100 = 241.2 / 250 \times 100 = 96\%$$

$$A_{11} = 12 / 12 \times 100 = 100\%$$

$$A_{21} = 5 / 8.5 \times 100 = 59\%$$

$$A_{31} = 1 / 2.5 \times 100 = 40\%$$

$$A_{41} = 2 / 3 \times 100 = 67\%$$

$$A_{42} = 1 / 3 \times 100 = 34\%$$

Accordingly, because the "Derating curve for ambient temperature" indicates that up to 100% of the maximum load can be used up to 50°C and the largest value amongst $A_0, A_{11}, A_{21}, A_{31}, A_{41},$ and A_{42} is 100%, this assures that these input and output conditions are acceptable.

[Example 2] Method to confirm that AM12-RHGFFE-0000 can be used under the following conditions.

Input voltage : 200VAC Ambient temperature : 50°C

Output model : slot1 : 5V 32A slot2 : 12V 16A slot3 : 12V 10A slot4 : 24V 8A (peak 15A) slot5 : 48V 4A
slot6 : 24V 2.5A, 24V 2.5A

According to the "Derating curve for input voltage", total output power is 1200W.

Calculating $A_{11} - A_{62}$

$$A_0 = (5 \times 32 + 12 \times 16 + 12 \times 10 + 24 \times 15 + 48 \times 4 + 24 \times 2.5 + 24 \times 2.5) / 1200 \times 100 = 1144 / 1200 \times 100 = 96\%$$

$$A_{11} = 32 / 32 \times 100 = 100\%$$

$$A_{21} = 16 / 20 \times 100 = 80\%$$

$$A_{31} = 10 / 20 \times 100 = 50\%$$

$$A_{41} = 8 / 10 \times 100 = 80\%$$

$$A_{51} = 4 / 5 \times 100 = 80\%$$

$$A_{61} = 2.5 / 3 \times 100 = 84\%$$

$$A_{62} = 2.5 / 3 \times 100 = 84\%$$

Accordingly, because the "Derating curve for ambient temperature" indicates that up to 100% of the maximum load can be used up to 50°C and the largest value $A_0, A_{11}, A_{21}, A_{31}, A_{41}, A_{51}, A_{61}$ and A_{62} is 96%, this assures that these input and output conditions are acceptable.

Instruction Manual

◆ It is necessary to read the “Instruction Manual” and “Before using our product” before you use our product.

Basic Characteristics Data

Model	Circuit method	Switching frequency [kHz]	Inrush current protection circuit	PCB/Pattern			Series/Parallel operation availability	
				Material	Single sided	Double sided	Series operation	Parallel operation
Input module of AME400F	Active filter	67	Relay	FR-4	-	Multilayer	N/A	N/A
	Half-bridge converter	133						
Input module of AME600F	Active filter	67	Relay	FR-4	-	Multilayer	N/A	N/A
	Half-bridge converter	133						
Input module of AME800F	Active filter	67	Relay	FR-4	-	Multilayer	N/A	N/A
	Half-bridge converter	133						
Input module of AME1200F	Active filter	67	Relay	FR-4	-	Multilayer	N/A	N/A
	Half-bridge converter	133						
Output module of A-D, J-M	Buck converter	266	-	FR-4	-	Multilayer	*1	N/A
Output module of E4-H4, E-H, S-V, V4, V5, 2C-2M	Buck converter	266	-	FR-4	-	Multilayer	*1	*1
Output module of P, Q, R	Buck converter	266	-	FR-4	-	Multilayer	*2	N/A

*1 Refer to “Series/Parallel Operation of Modular Power Supply” in the instruction manual.

*2 Series operation is possible, but series connection cannot be set by the series code.

Authorised, valued-added distributor

Australia & New Zealand



Powerbox Australia Pty Ltd

Sydney Head Office
4 Beaumont Road,
Mt Kuring-Gai, NSW 2080
Australia



1800 251 380



sales@powerbox.com.au



powerbox.com.au

Powerbox Pacific Ltd

New Zealand Sales Office
1a Henry Rose Place,
Albany, Auckland
New Zealand 0632



09 4158 320



sales@powerbox.co.nz



powerbox.co.nz